

FLAT PACK OFFICE CABIN

3.3M INSTALLATION INSTRUCTIONS

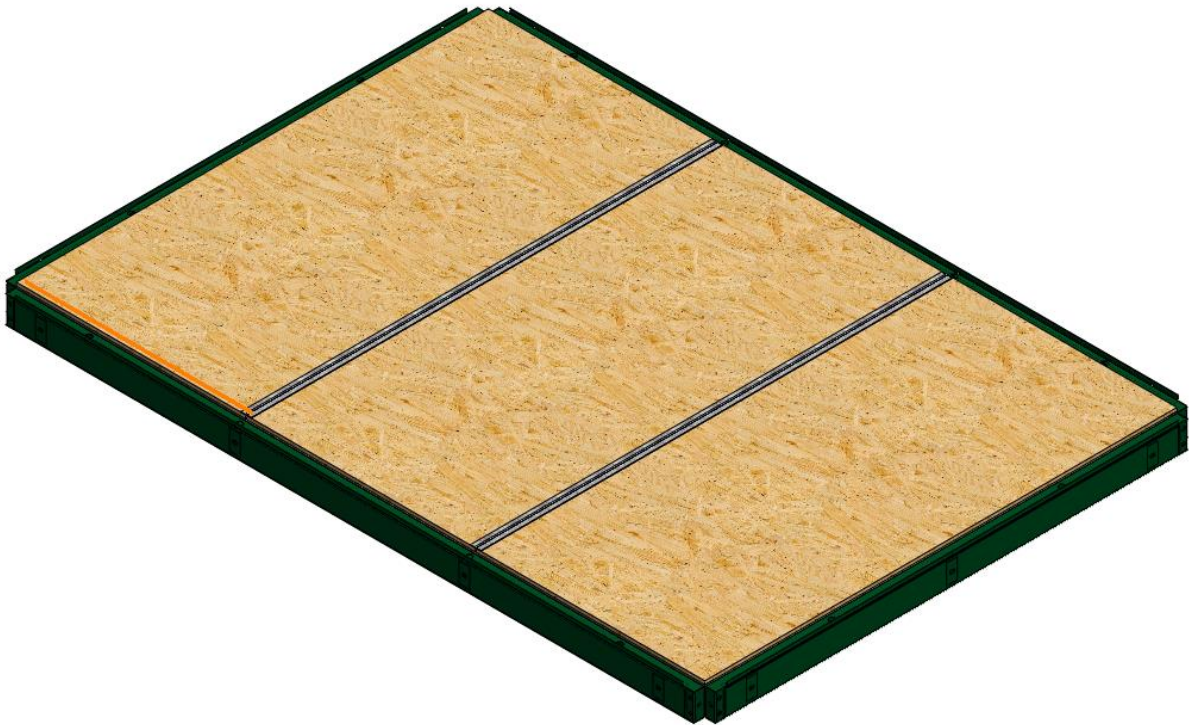

1. The chassis is placed on a flat surface.



2. First the inner corner profile is fixed to the chassis using bolts.

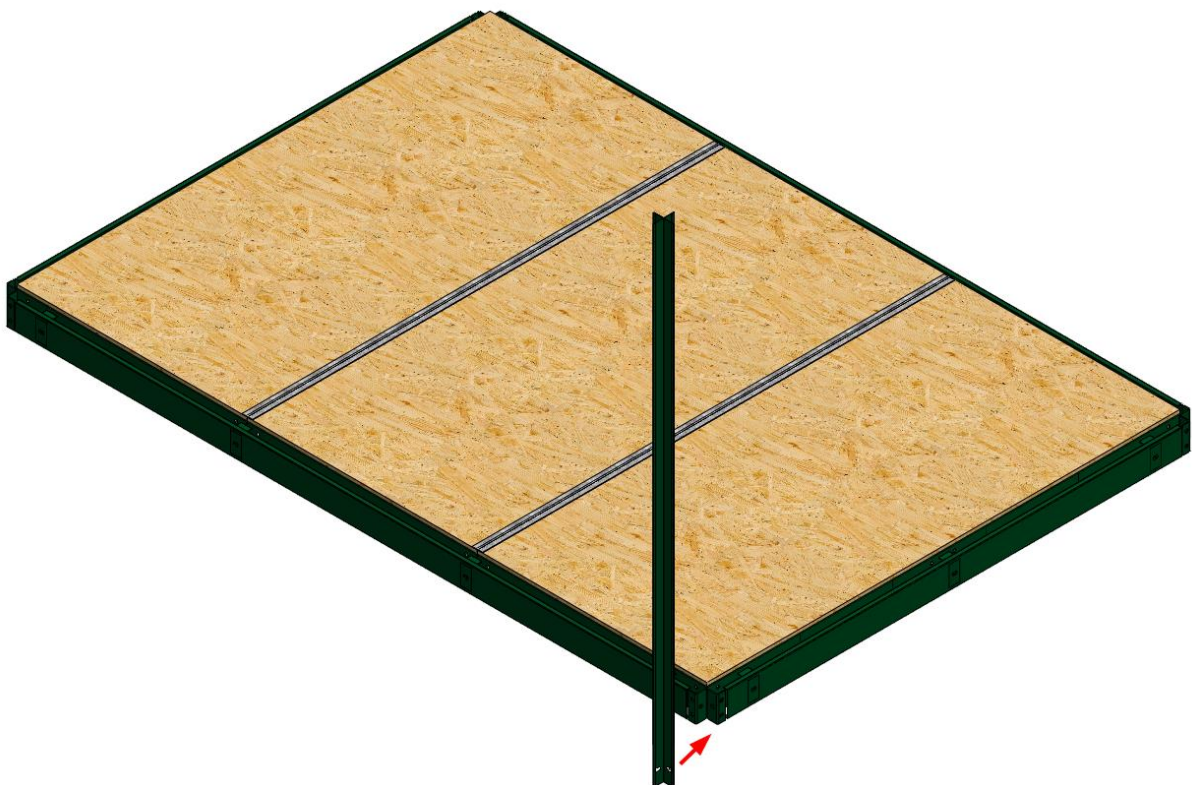



M12x25 MM BOLT+WASHER

3. The outer corner profiles are also fixed to the chassis with bolts in the same way.

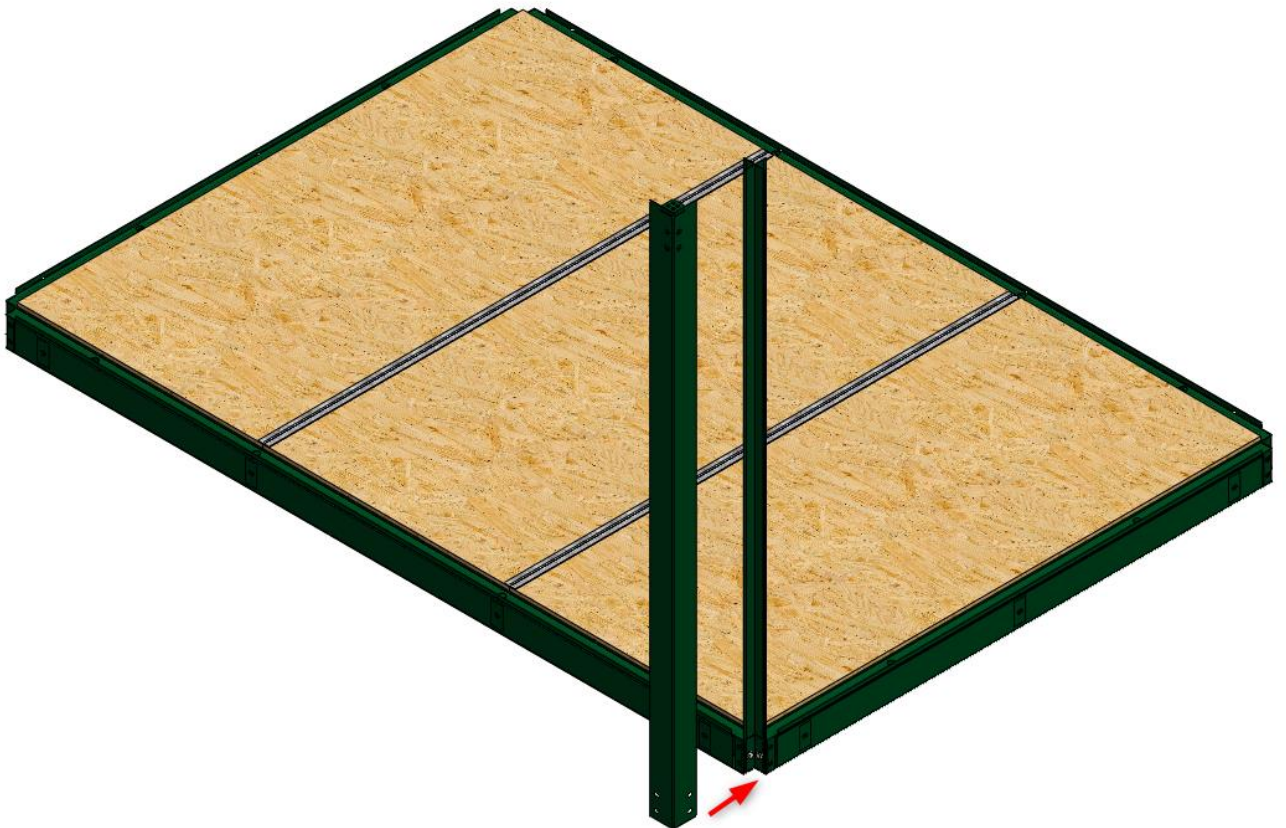

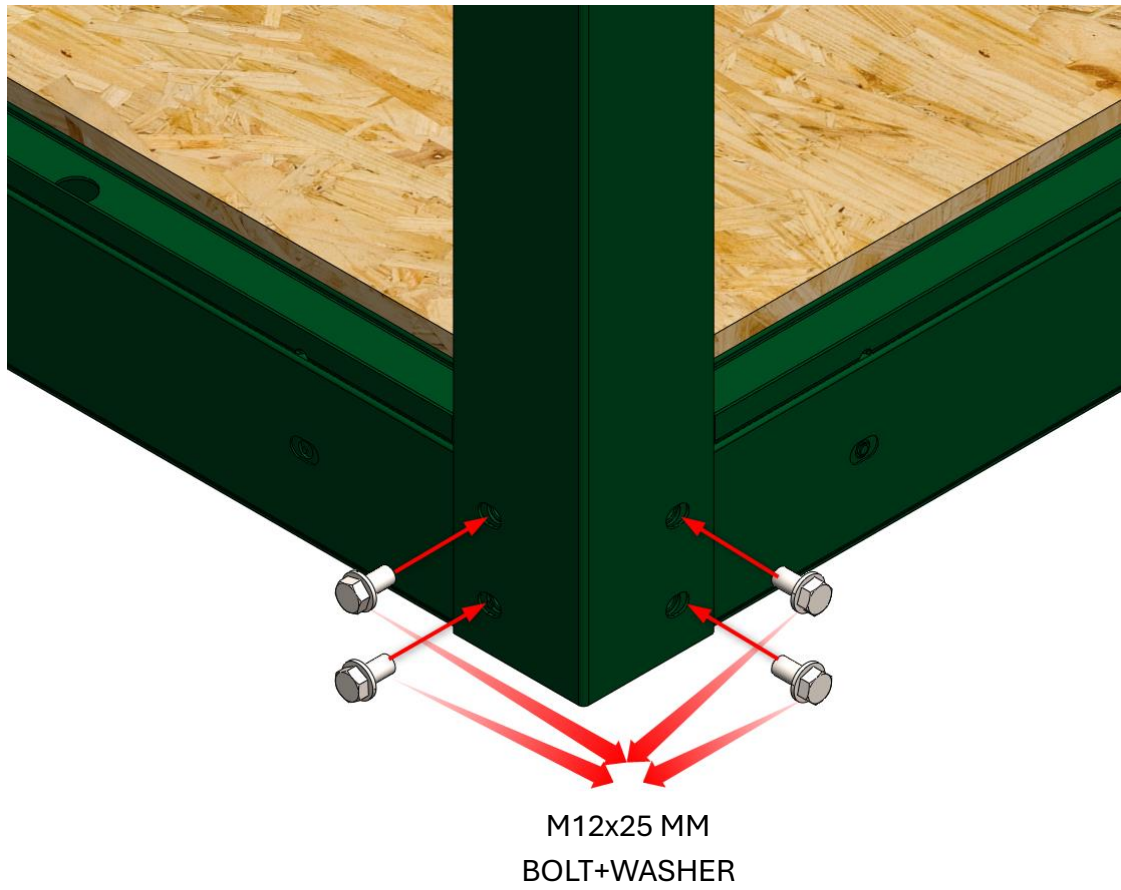

4. After the corner profiles are fixed, the 593 mm female panel is installed.

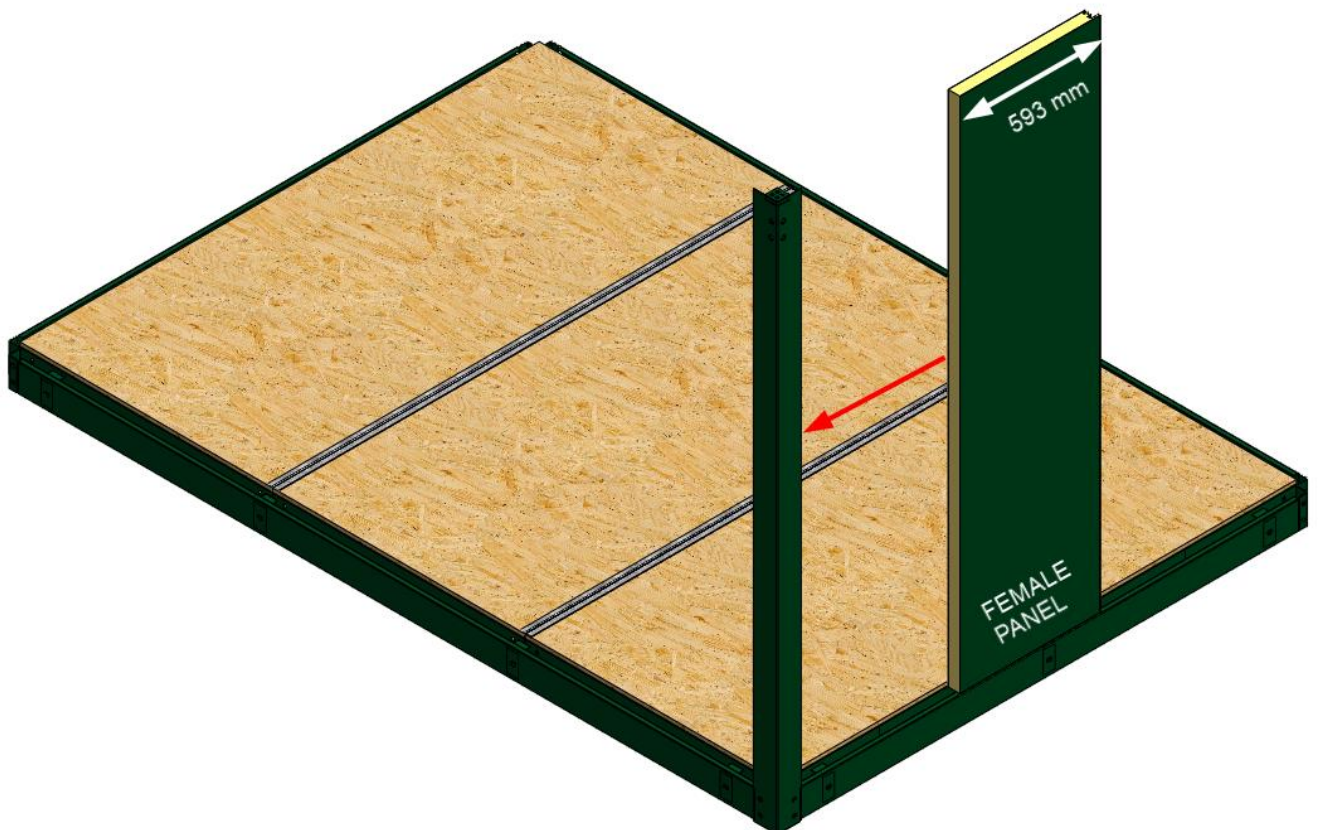

5. Afterward, the door panel and the 593 mm male panel are installed.

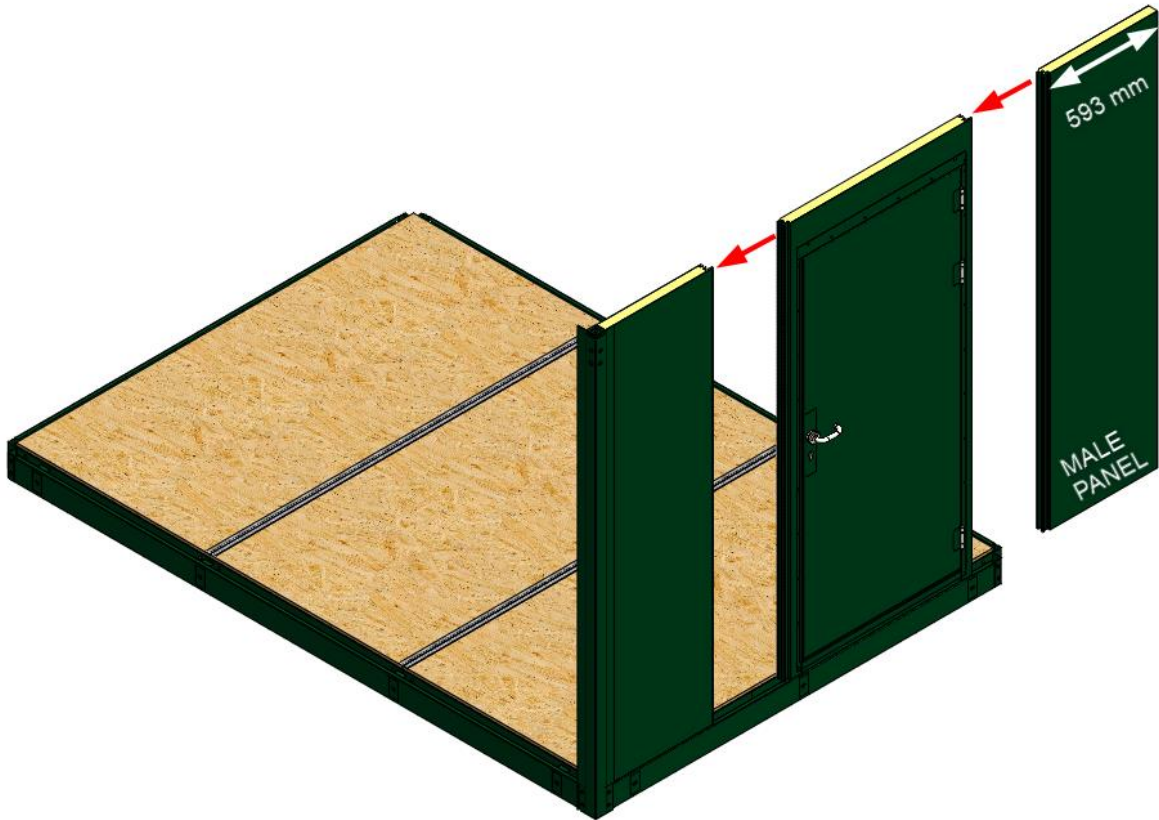

6. The inner and outer corner profiles are bolted in the same order to the other end of the panel, completing the installation of the end panel.



7. In this step, 3 full panels and a 189 mm female panel are installed.

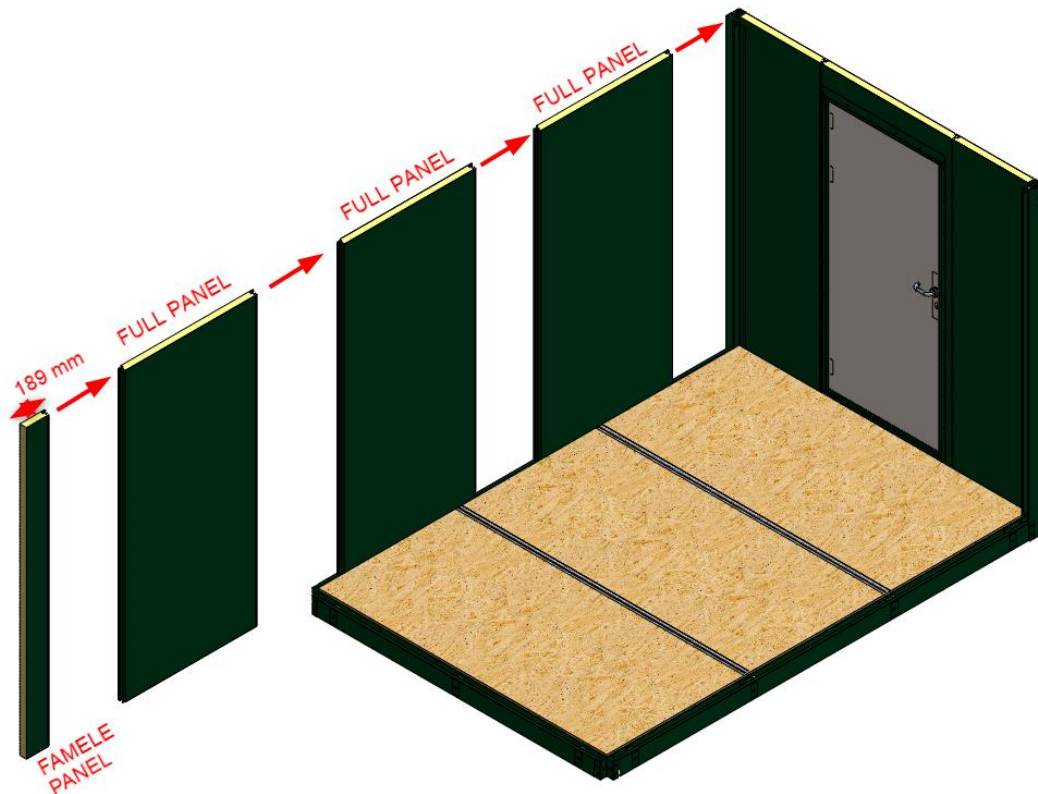

8. The inner and outer corner profiles are bolted in the same order to the other end of the panel, completing the installation of the end panel.

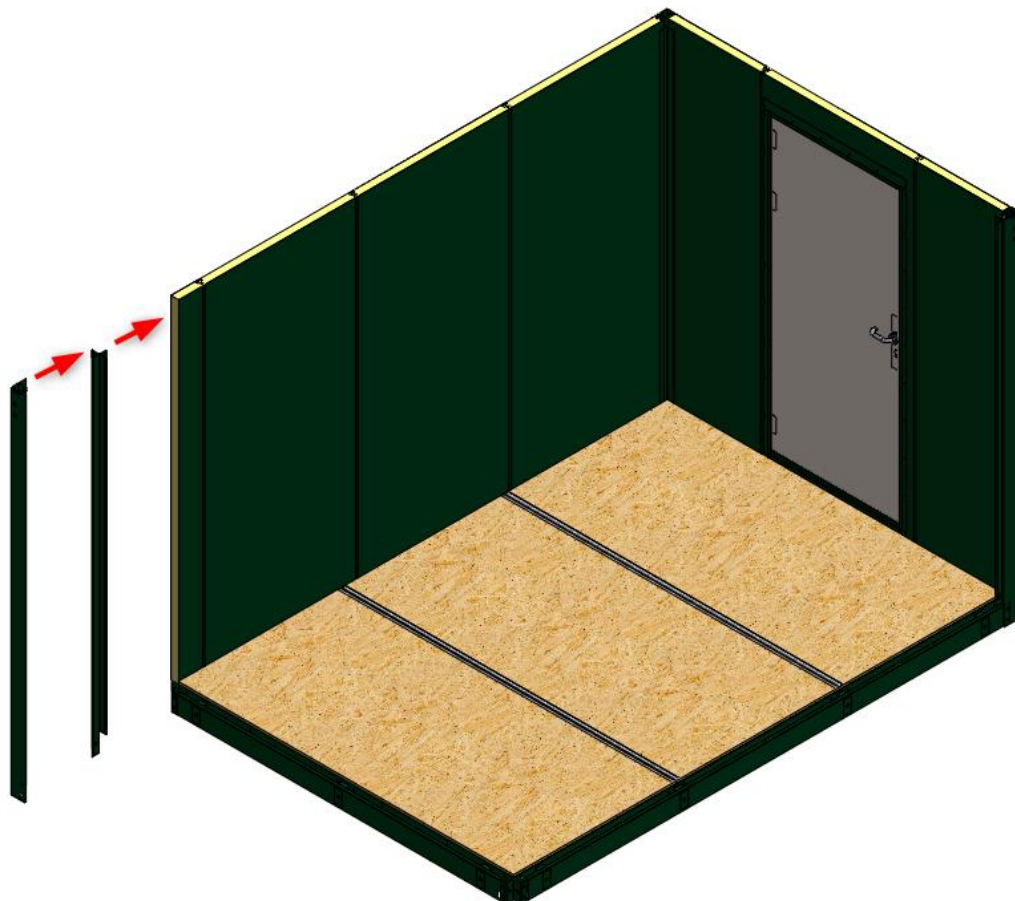

9. In this step, 1 piece of 593 mm female panel, 1 full panel, and 1 piece of 593 mm male panel are installed.

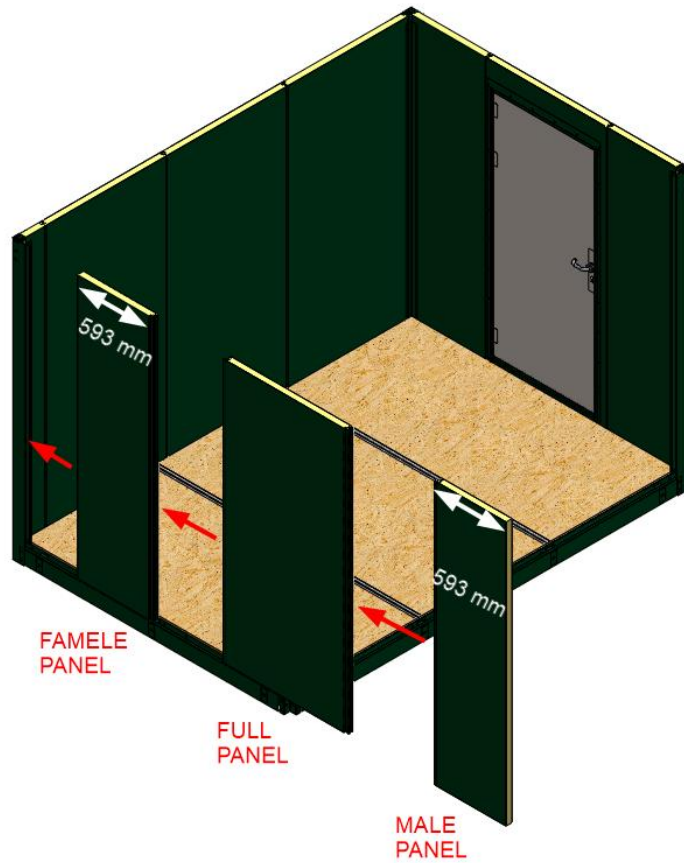

10. The inner and outer corner profiles are bolted in the same order to the other end of the panel, completing the installation of the end panel.

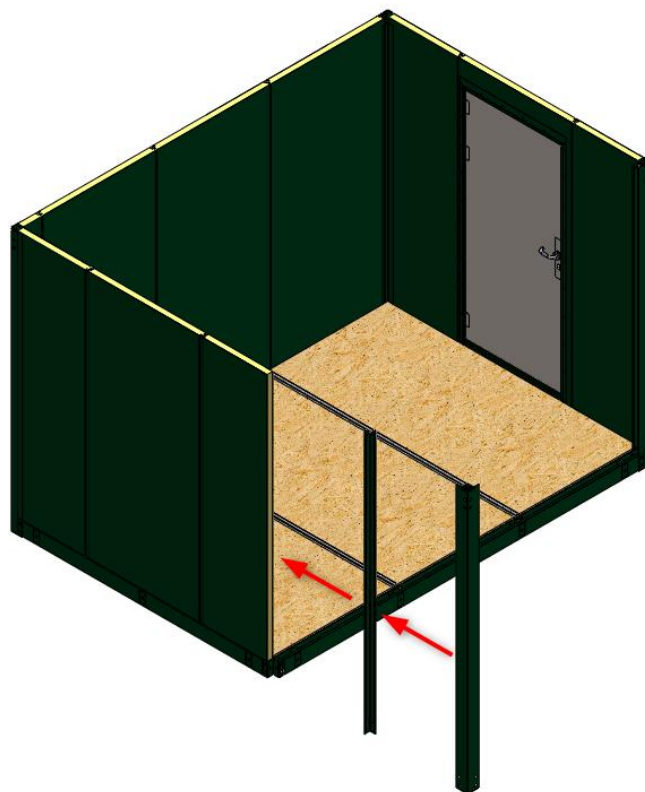

11. One 159 mm male panel, one full panel, and one windowed panel are placed as shown in the figure. One more windowed panel will be added to this section, which will be shown in the next step.

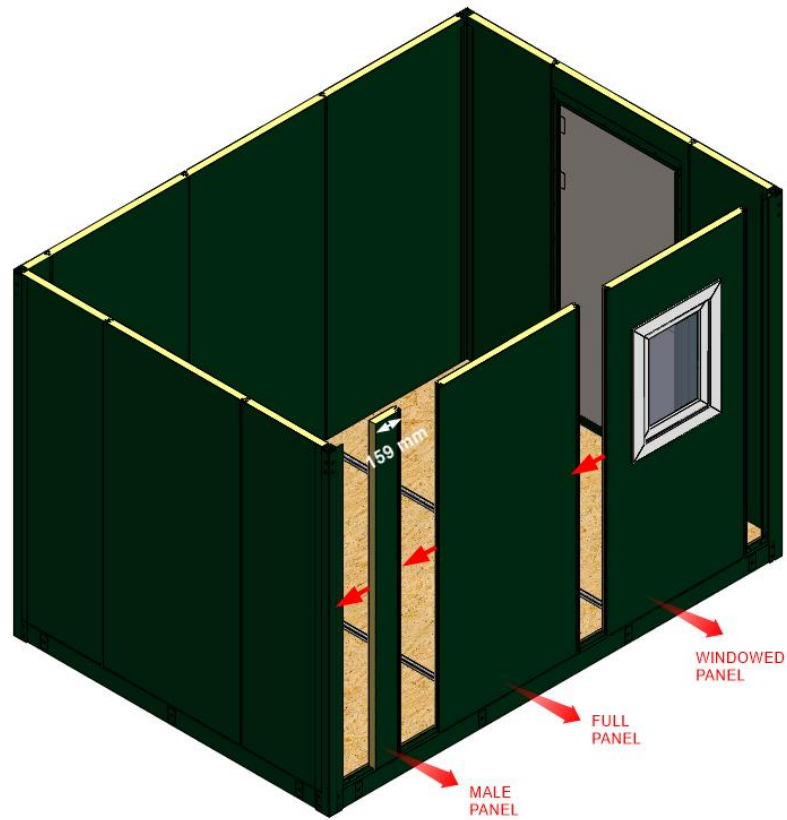

12. The final panel is placed from top to bottom as shown in the figure..

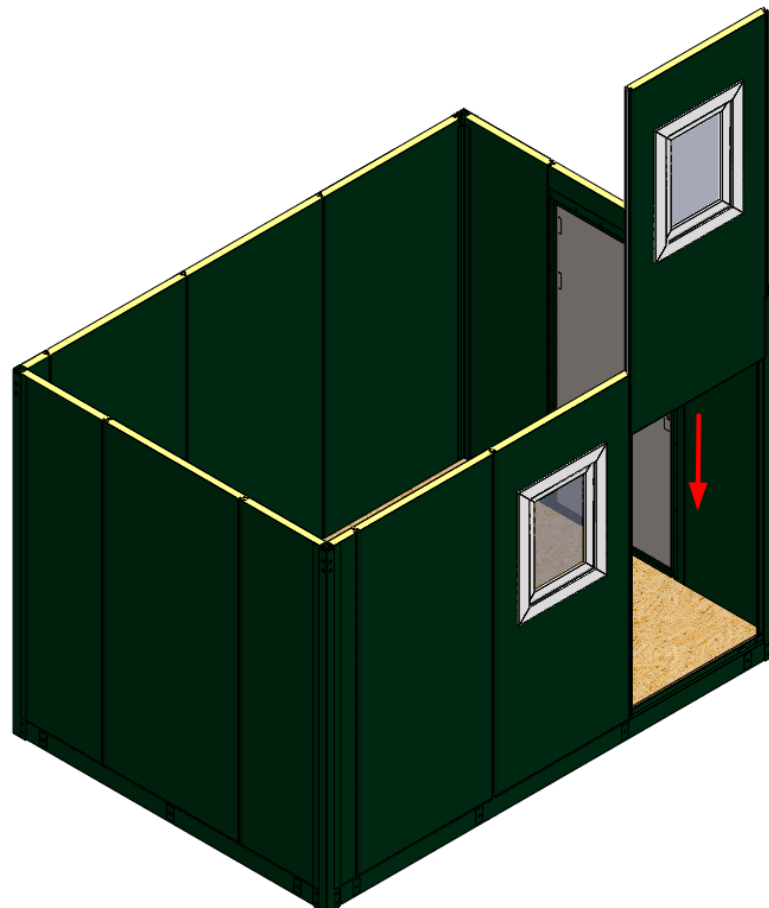

13. Pinned U profiles are placed so that the pins fit perfectly into the holes.

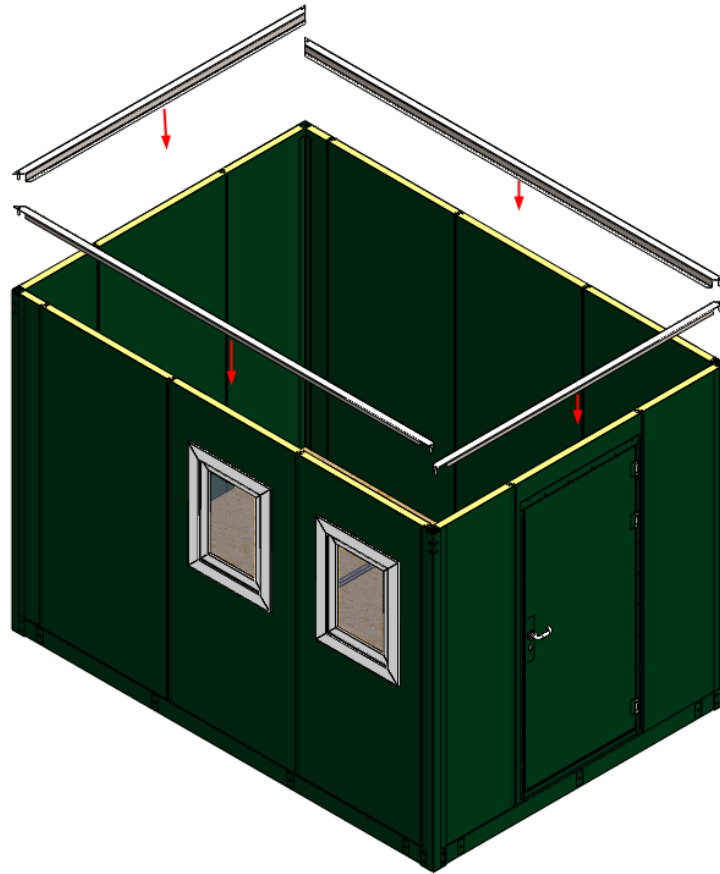

14. In this step, 3 full panels and 1 piece of 159 mm male or female panel will be installed. The 159 mm panel on the ceiling can be either male or female. Depending on whether it is male or female, its position can be adjusted to either end.

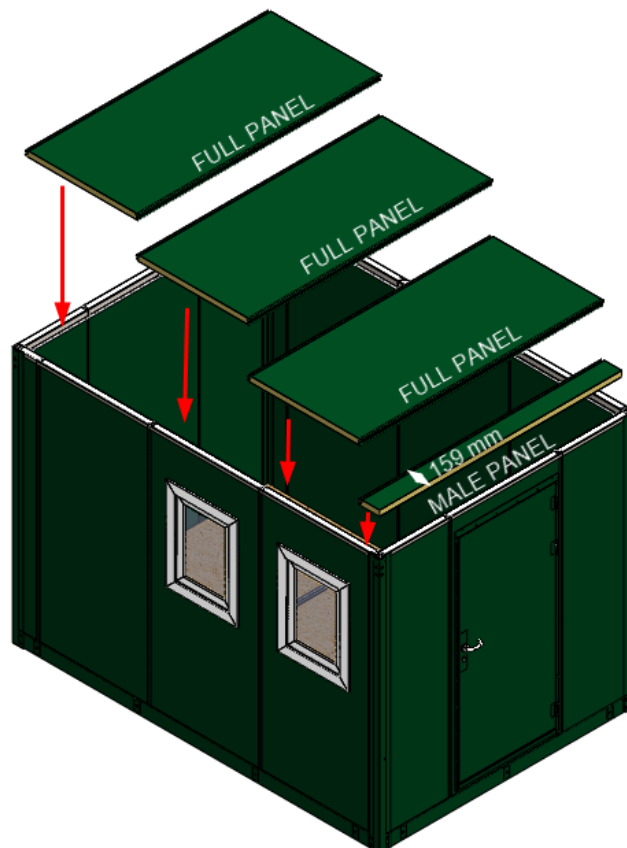

15. At this stage, the rain profile is placed on top of the pinned U profile.

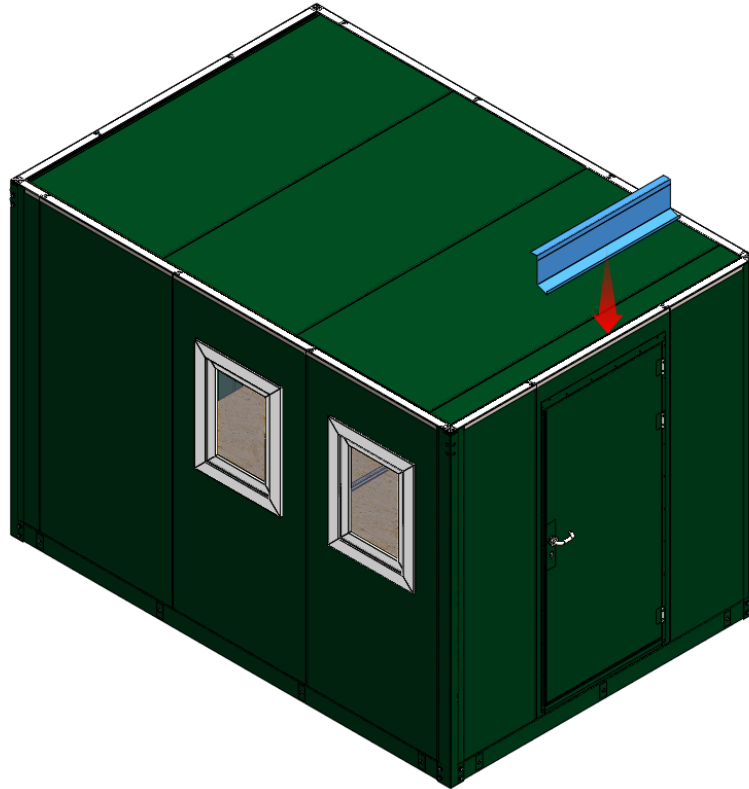

16. A metal sealed roof is placed on top of the sandwich panels on the roof side.

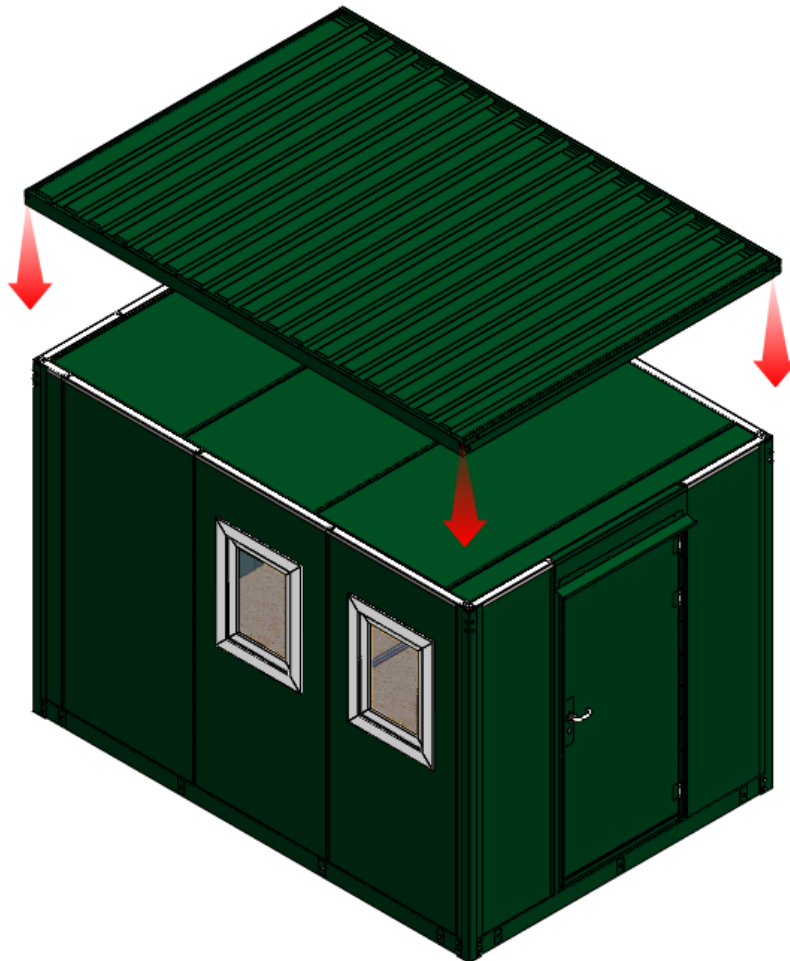

17. The lifting parts are fixed to the corner profiles and the roof with bolts. The roof is fixed to the product and allows it to be carried by crane. The product is ready to use.

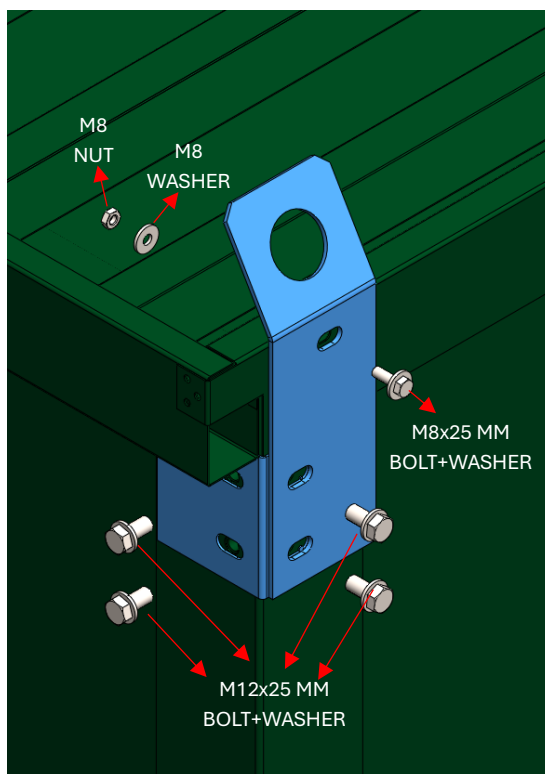
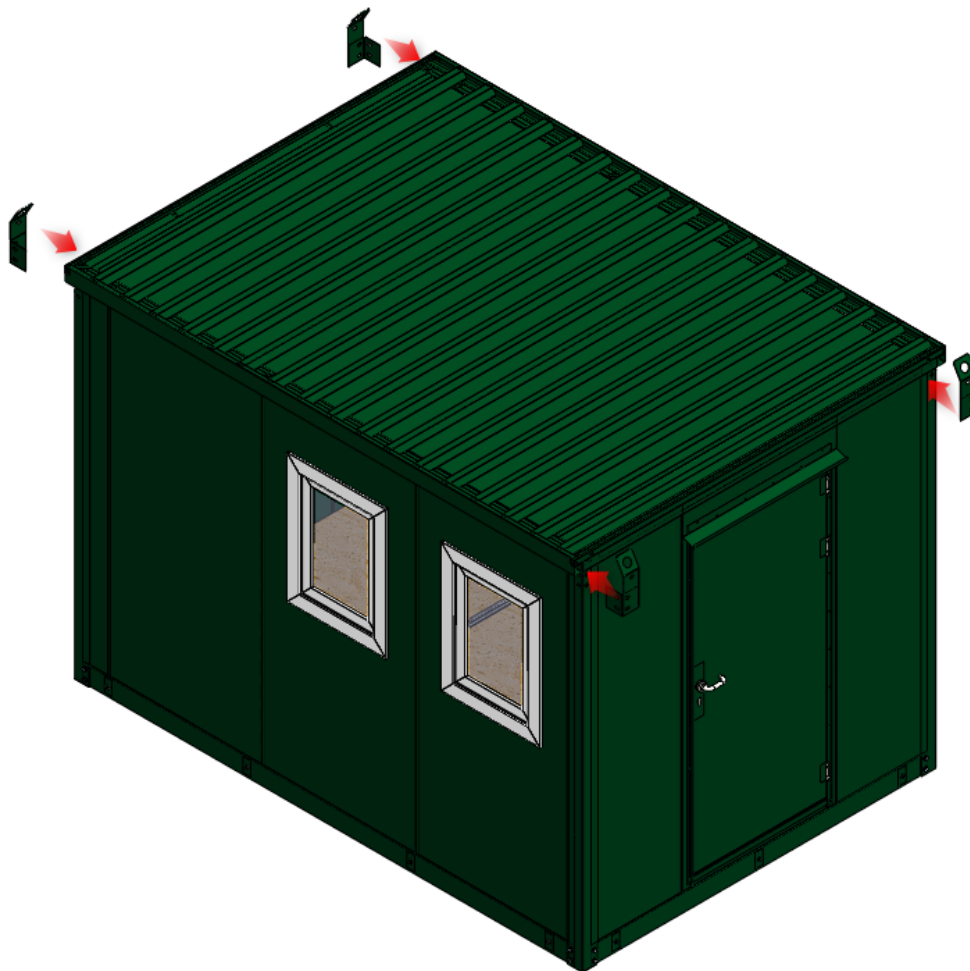



portablespace[®]

cabin & container hire | sales | conversions | modular

Portable Space Ltd,
Modular House, Bacton Business Park,
Stowmarket, Suffolk, IP14 4LE

T: +44(0) 01449 782123
info@portablespace.co.uk
www.portablespace.co.uk