

FLAT PACK OFFICE CABIN

END LINKING KIT INSTALLATION INSTRUCTIONS

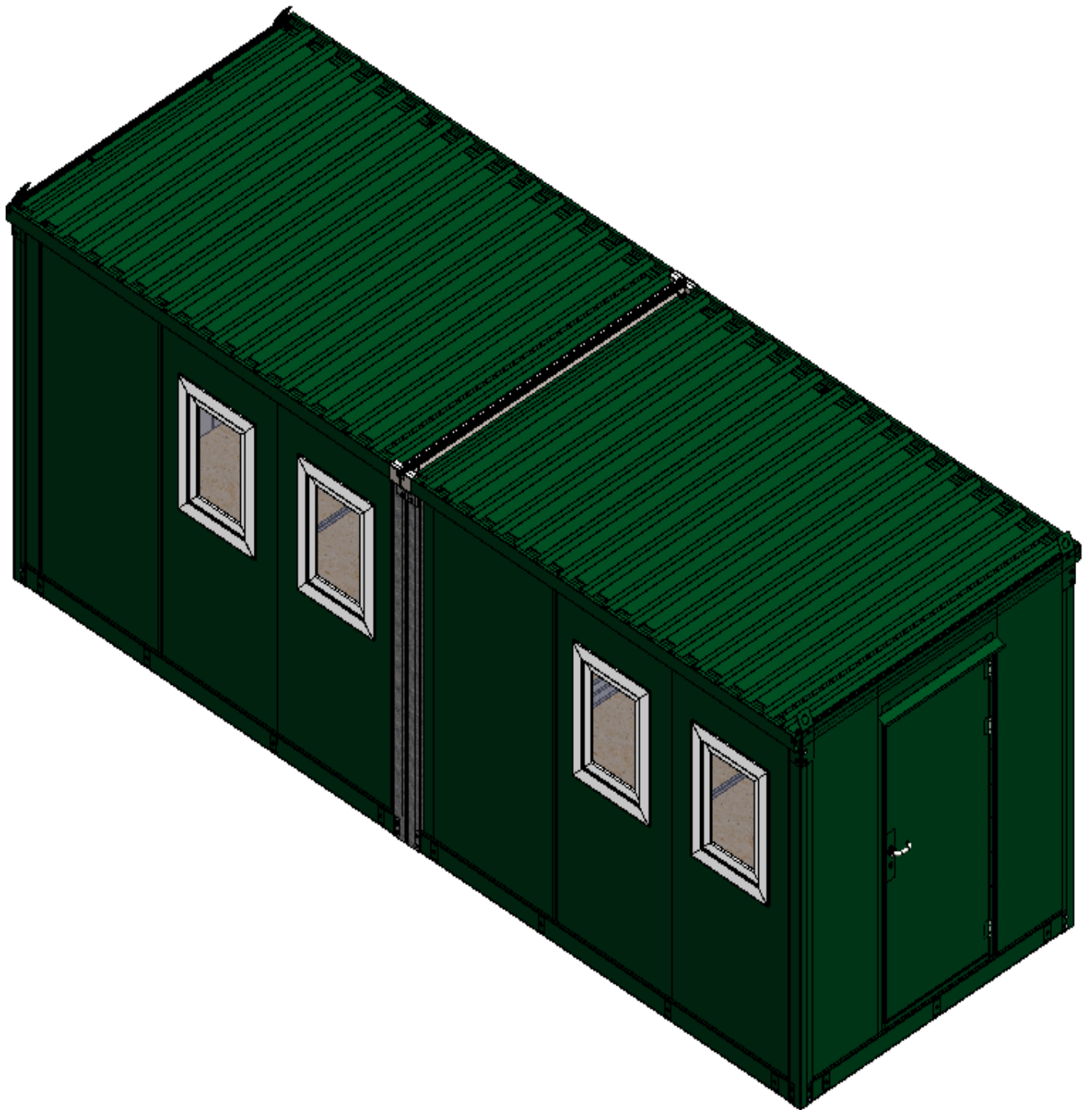

1. The chassis is placed on a flat surface.

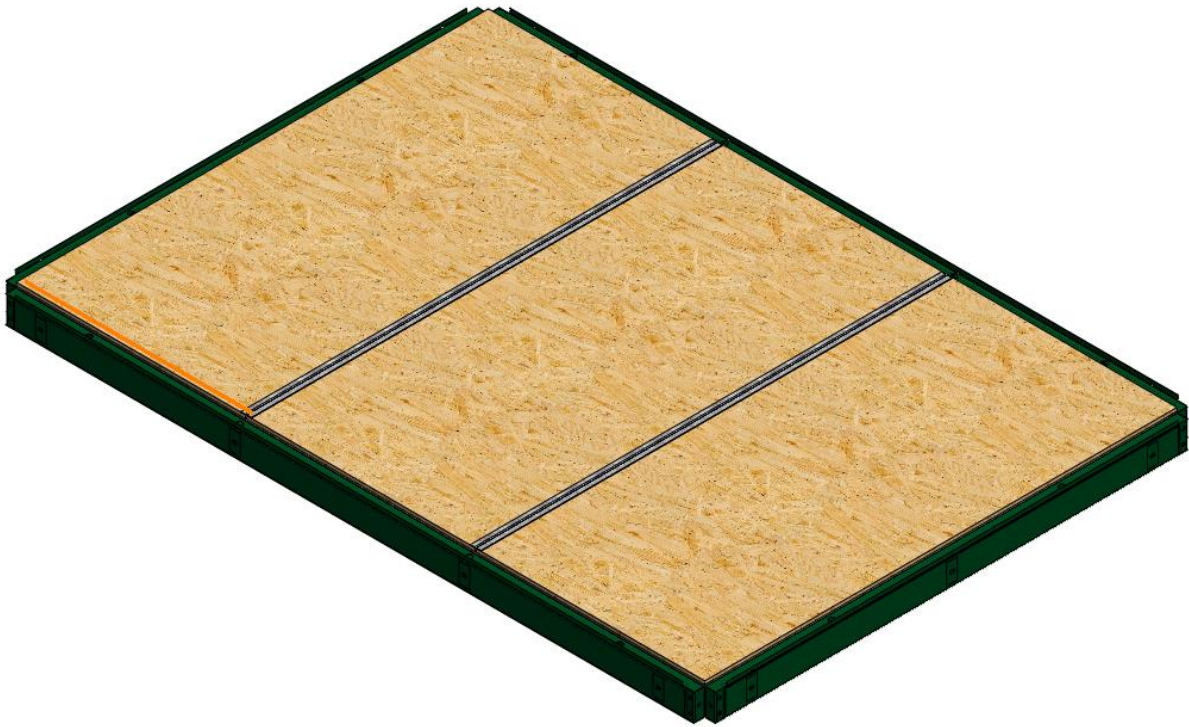

2. First the inner corner profile is fixed to the chassis using bolts.

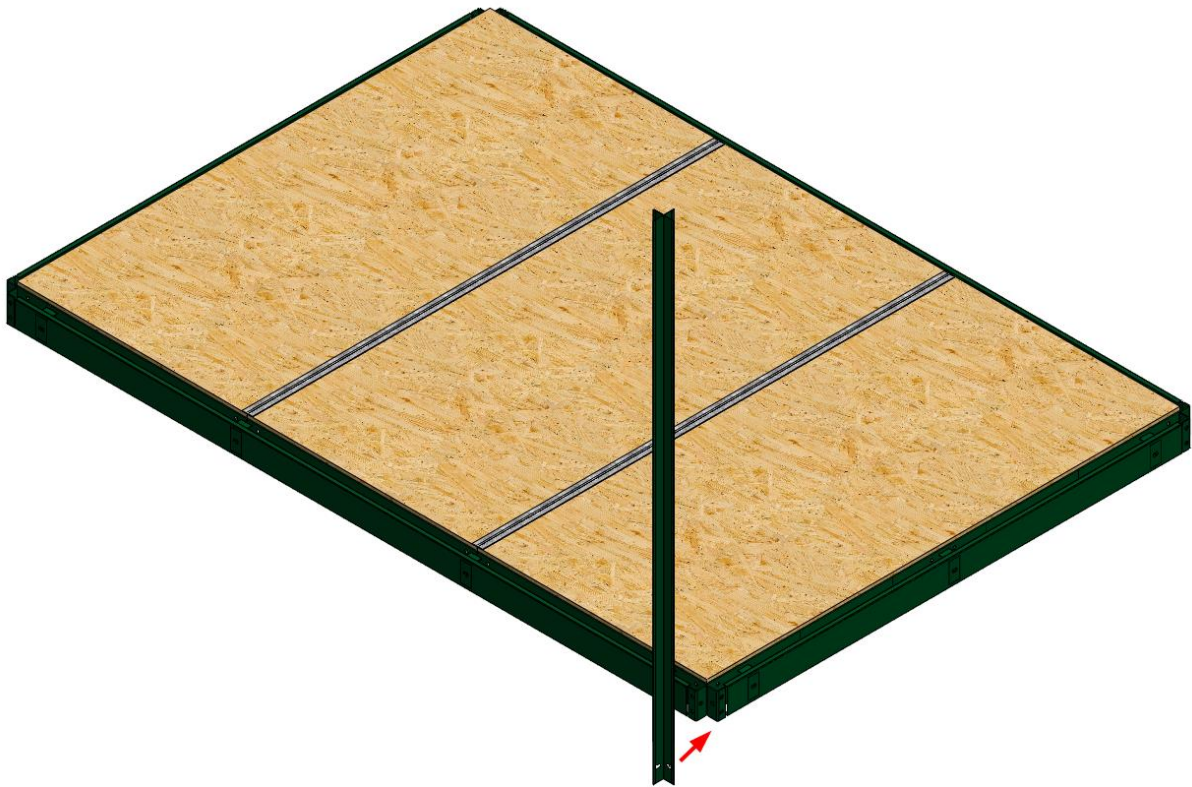

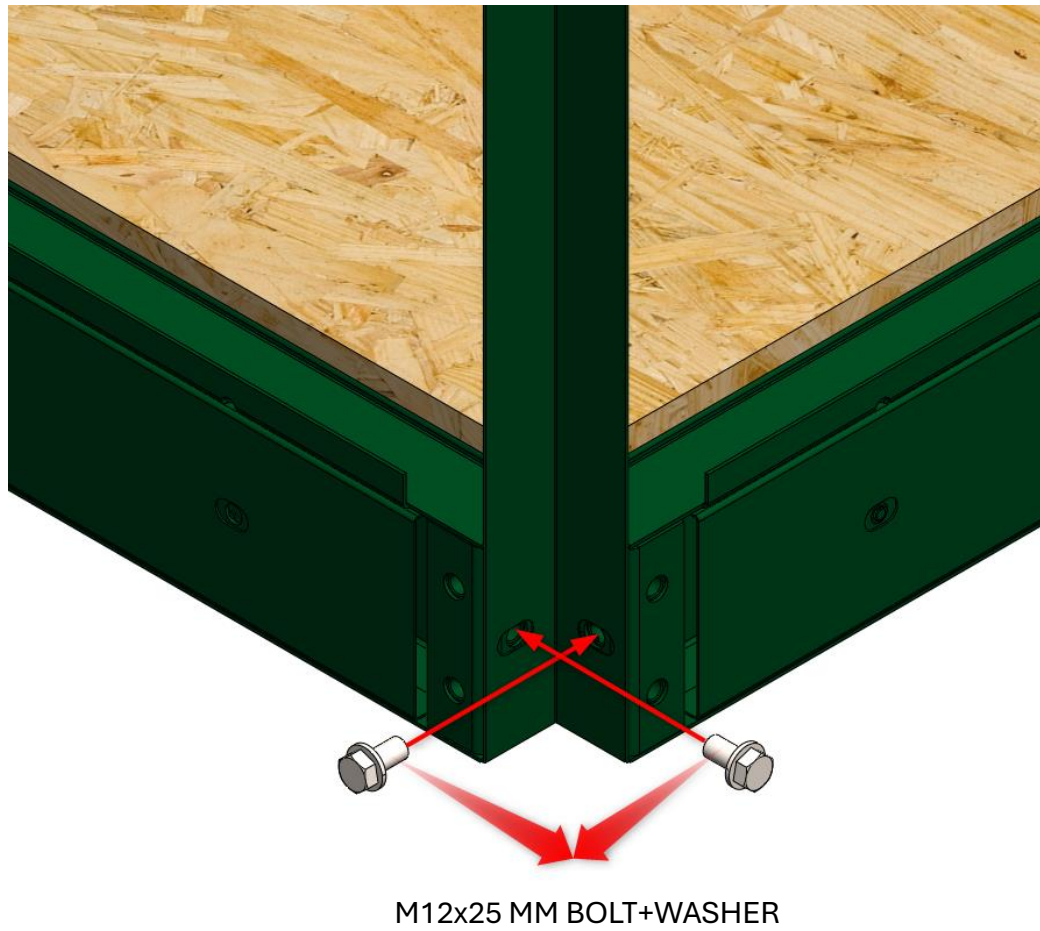

3. The outer corner profiles are also fixed to the chassis with bolts in the same way.

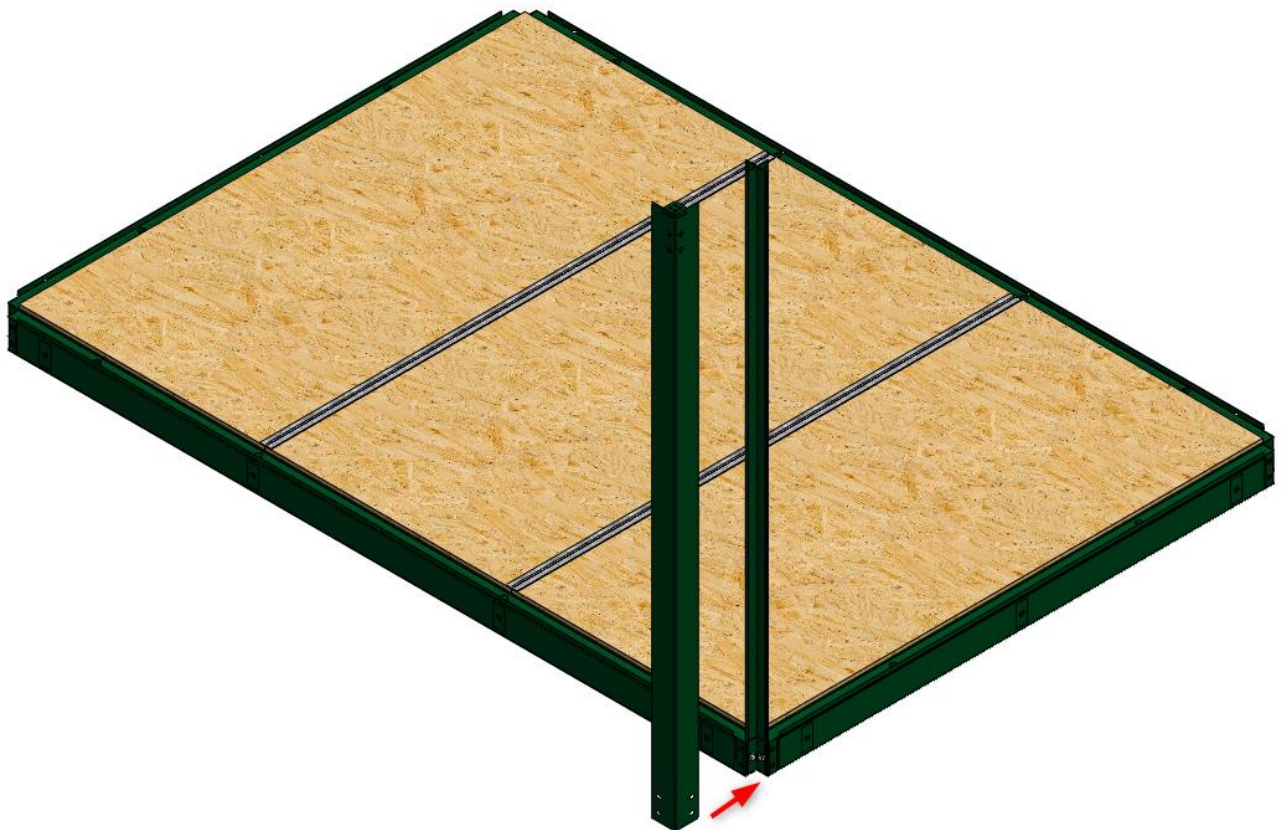

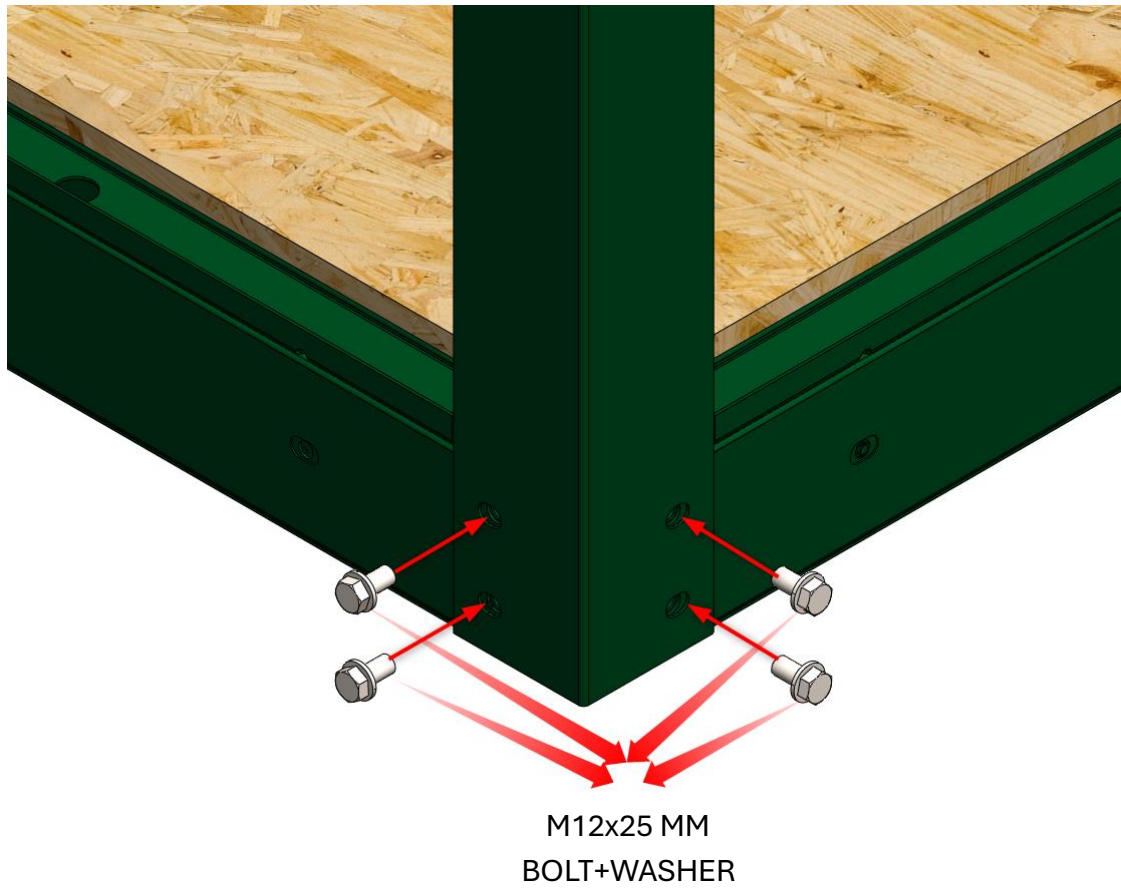

4. After the corner profiles are fixed, the 593 mm female panel is installed.

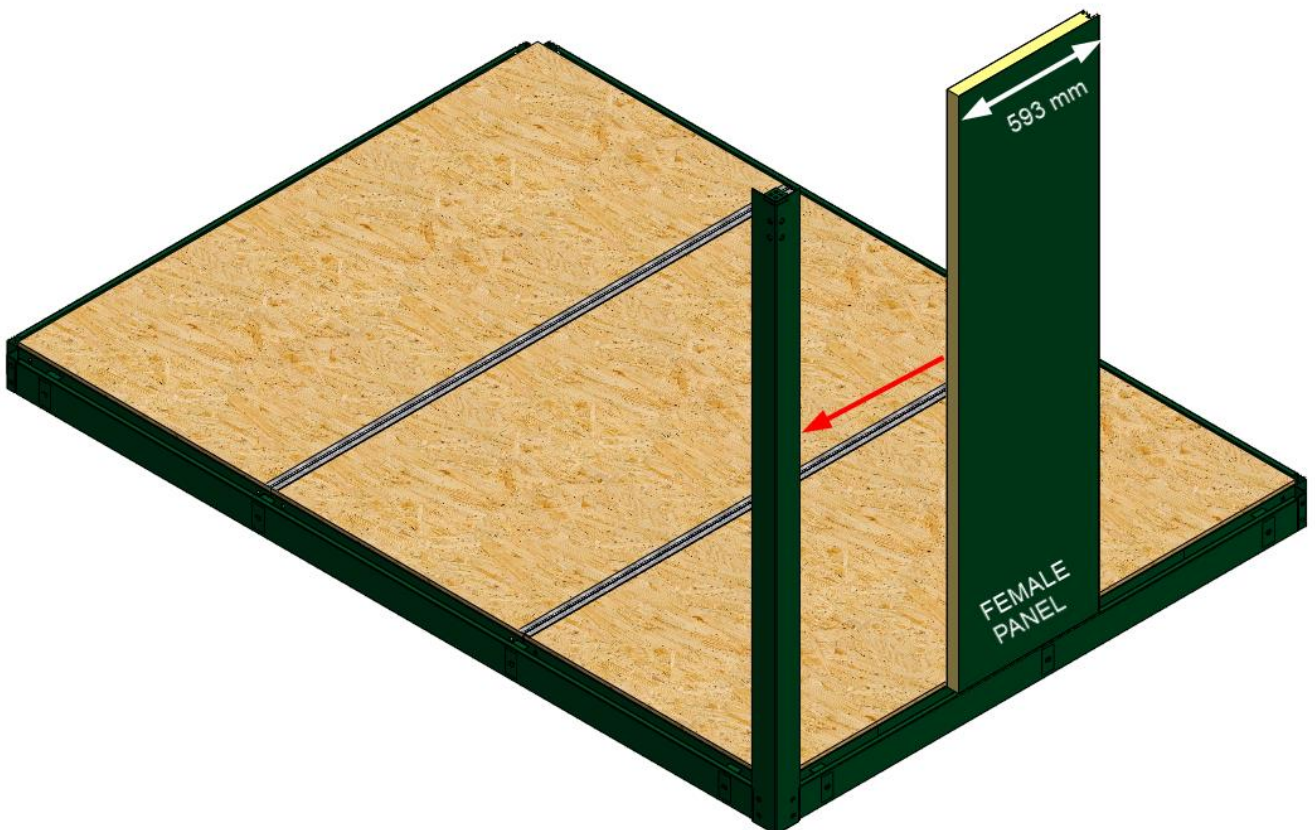

5. The door panel and the 593 mm male panel are installed.

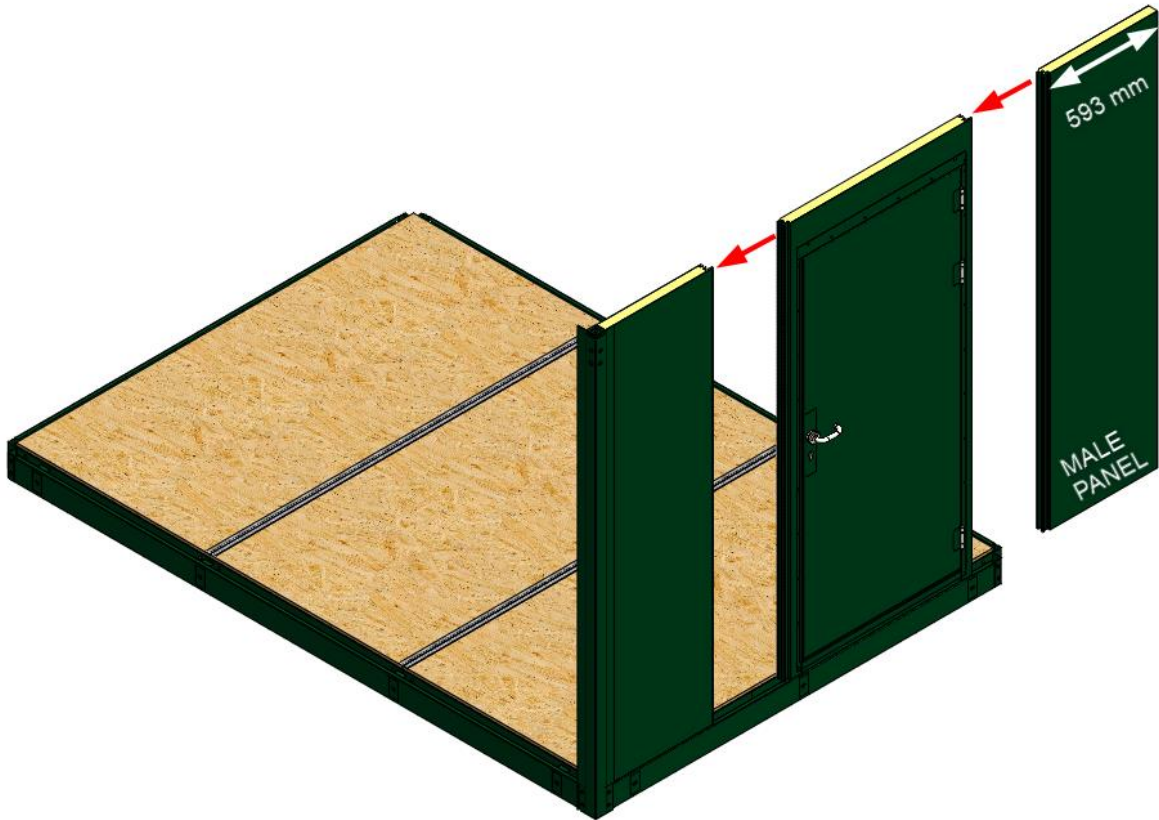

6. The inner and outer corner profiles are bolted in the same order to the other end of the panel, completing the installation of the end panel.



7. In this step, 3 full panels and a 189 mm female panel are installed.

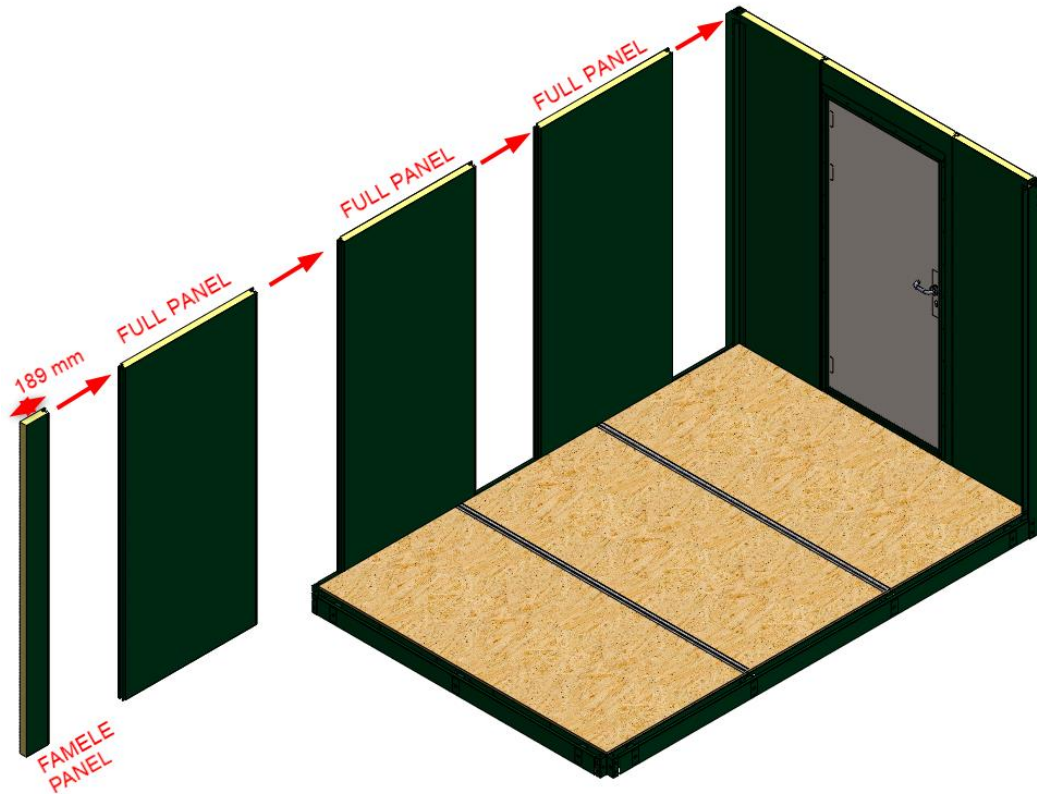

8. The inner and outer corner profiles are bolted in the same order to the other end of the panel, completing the installation of the end panel.

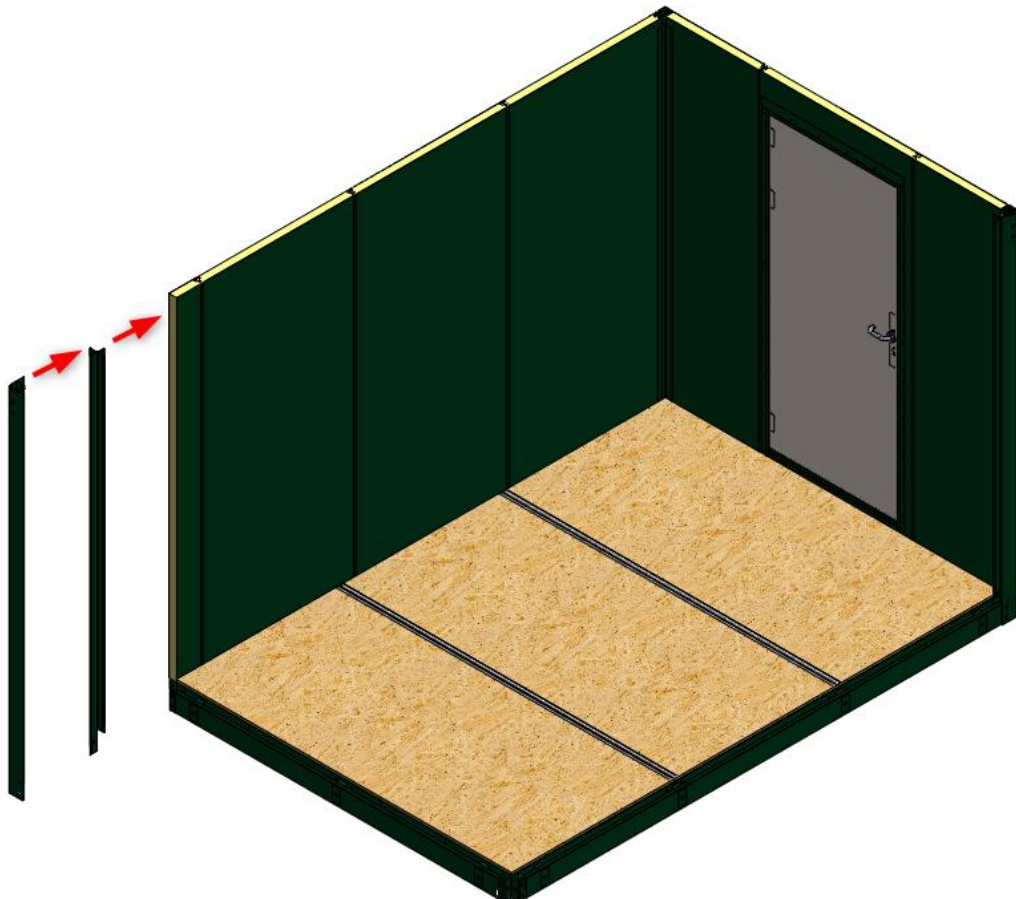

9. In this step, the panels on the other side are placed. The installation of two panels with windows, one full panel, and the 159 mm male panel is completed.

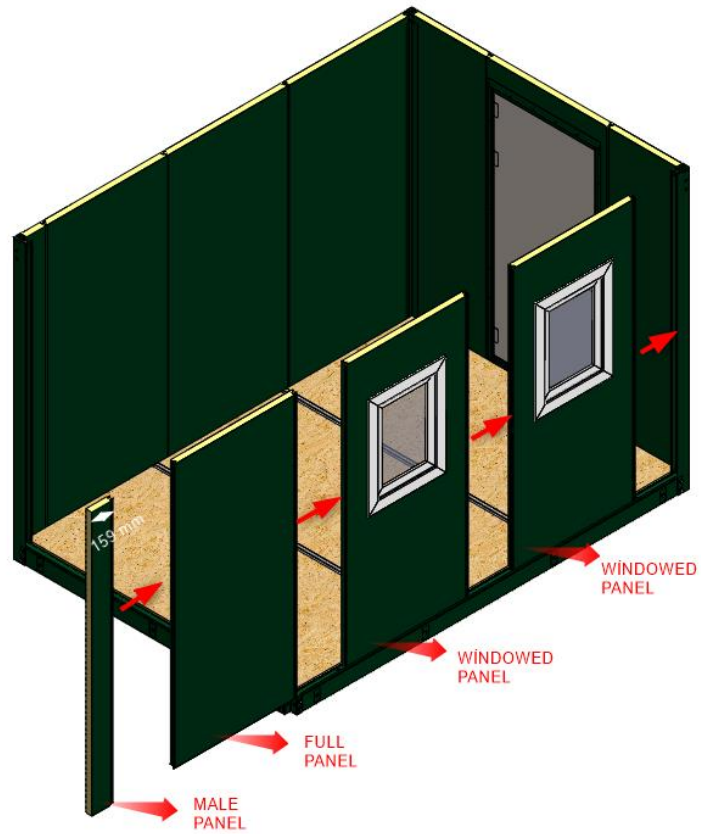

10. The inner and outer corner profiles are bolted in the same order to the other end of the panel, completing the installation of the end panel.

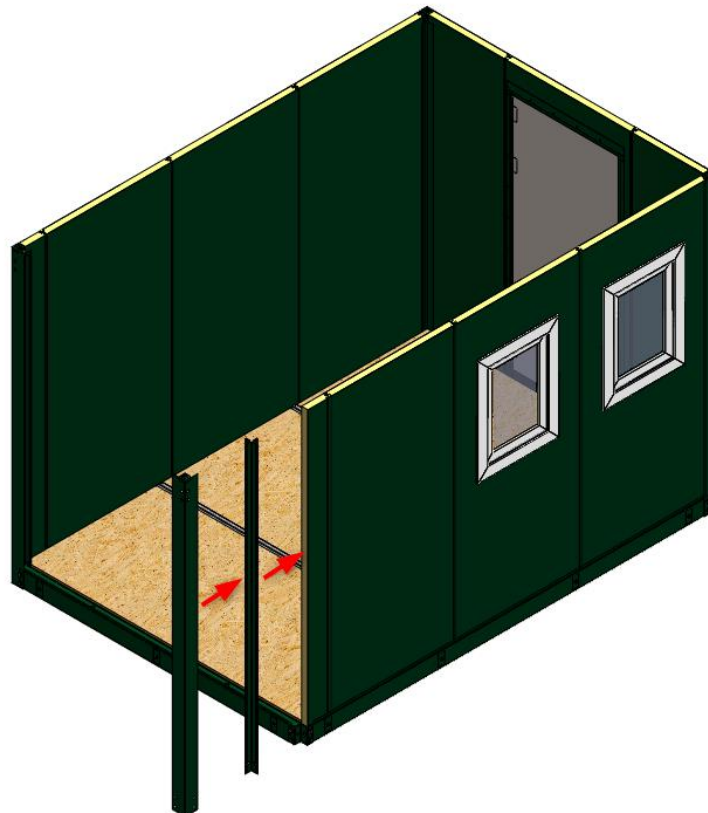

11. Pinned U profiles are placed so that the pins fit perfectly into the holes.

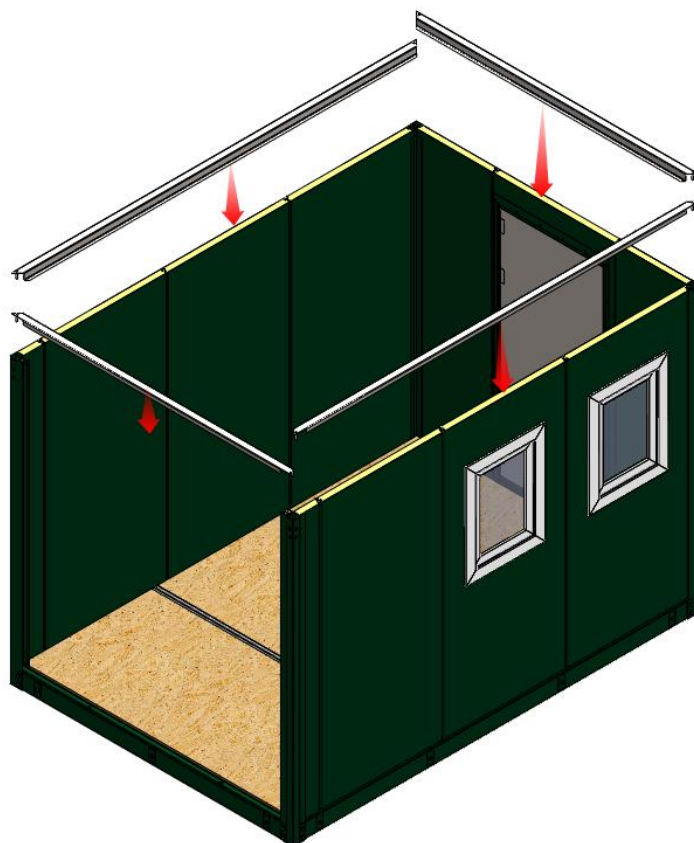

12. In this step, 3 full panels and 1 piece of 159 mm male or female panel will be installed. The 159 mm panel on the ceiling can be either male or female. Depending on whether it is male or female, its position can be adjusted to either end.



13. At this stage, the rain profile is placed on top of the pinned U profile.

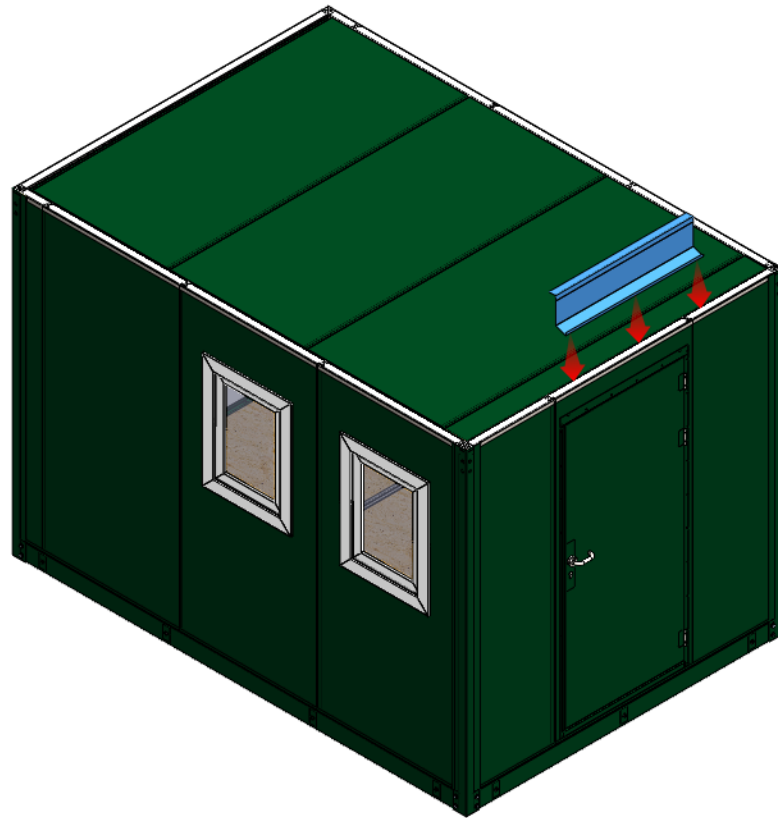

14. A metal sealed roof is placed on top of the sandwich panels on the roof side.

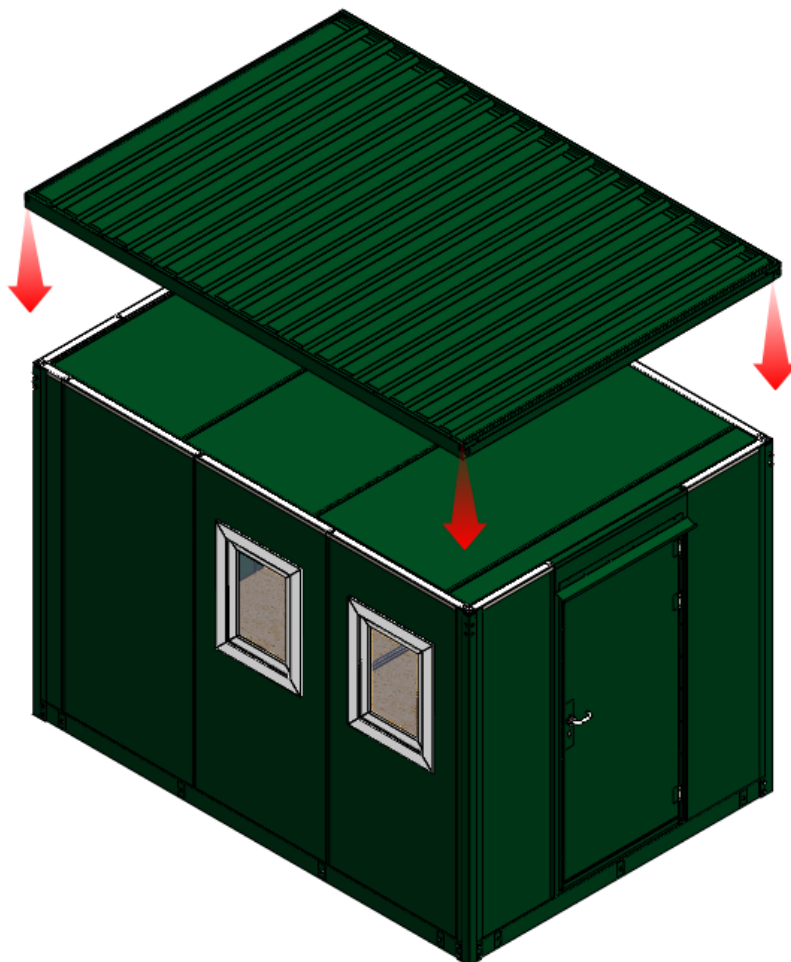

15. The lifting parts are fixed to the corner profiles and the roof with bolts. The roof is fixed to the product.

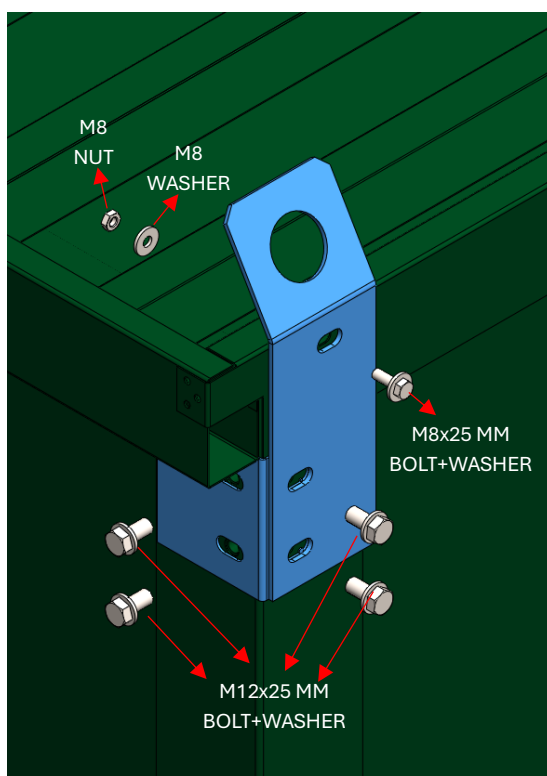
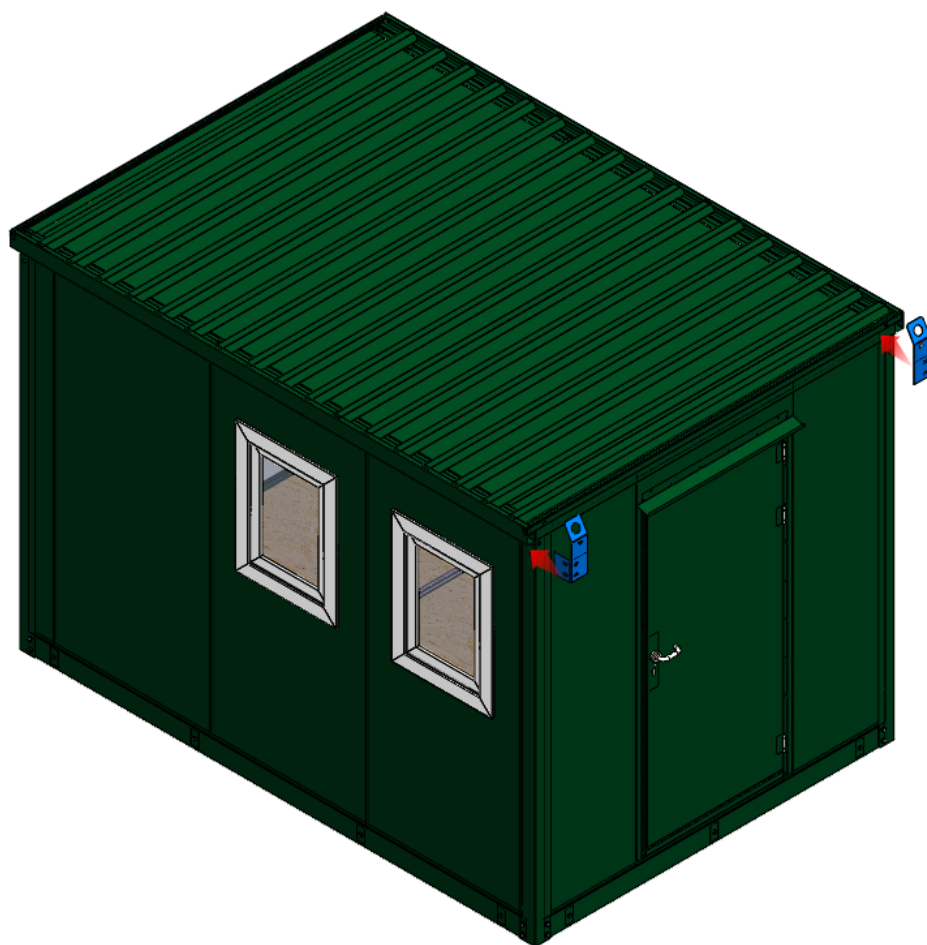

16. The first assembly is ready.

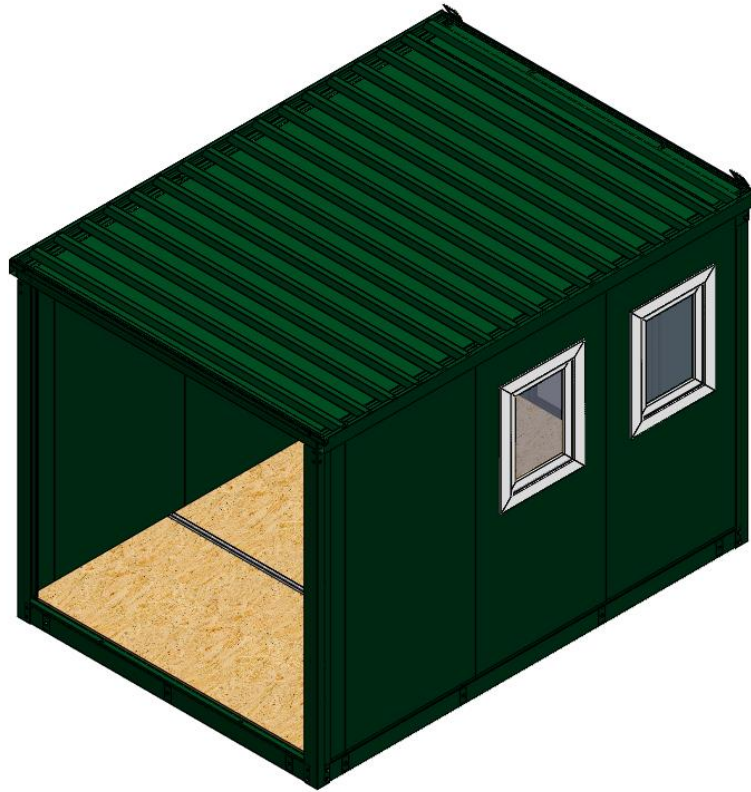

17. Repeat the same procedure for the assembly of the second cabin.

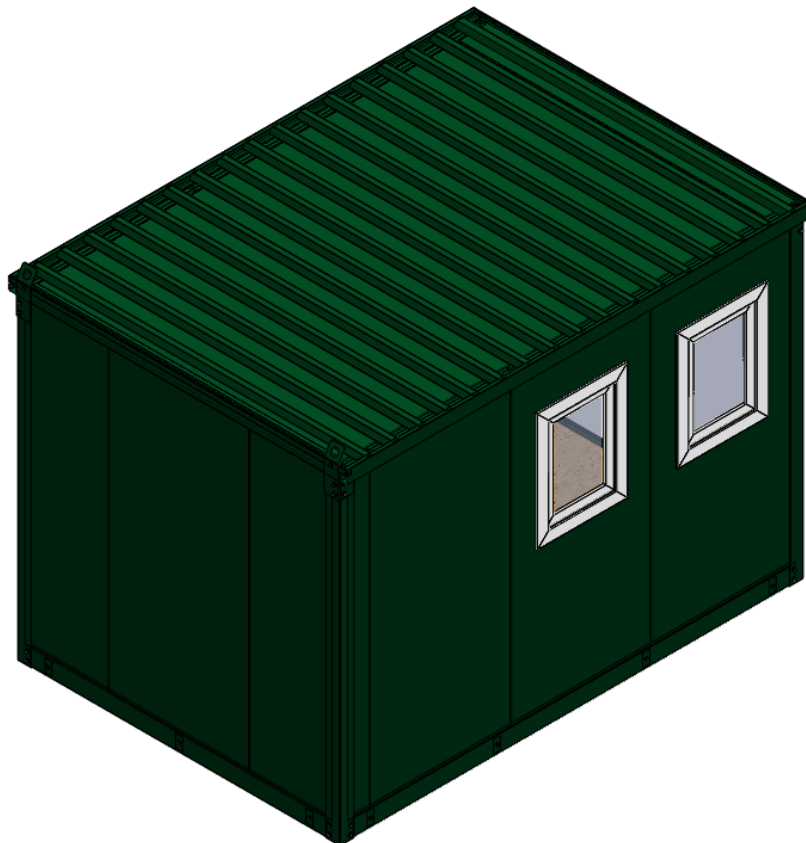

18. To link the cabins they will need to be close to each other

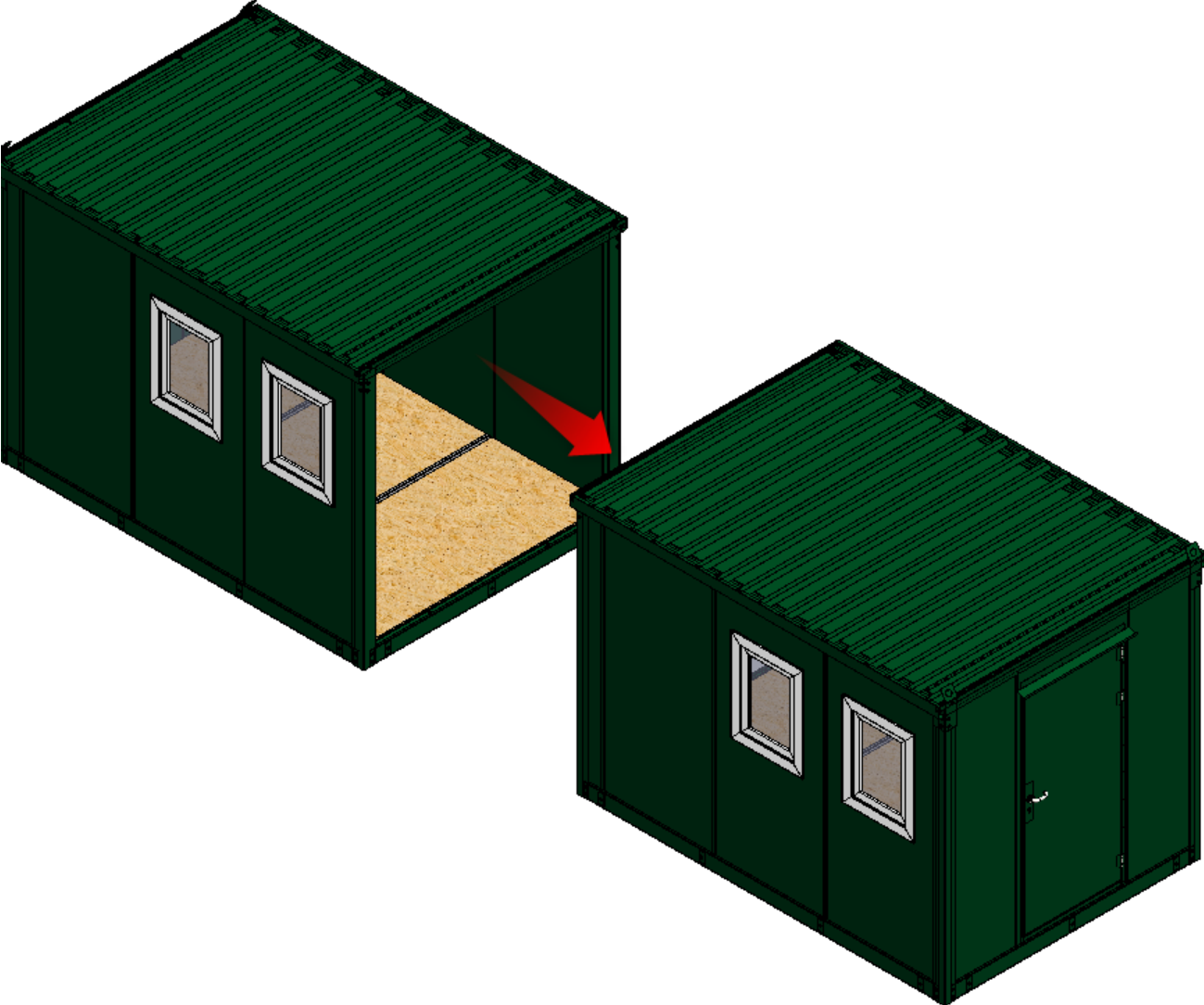

19. The part shown below is compressed from the inside of the cabin between the two roofs, towards the top.

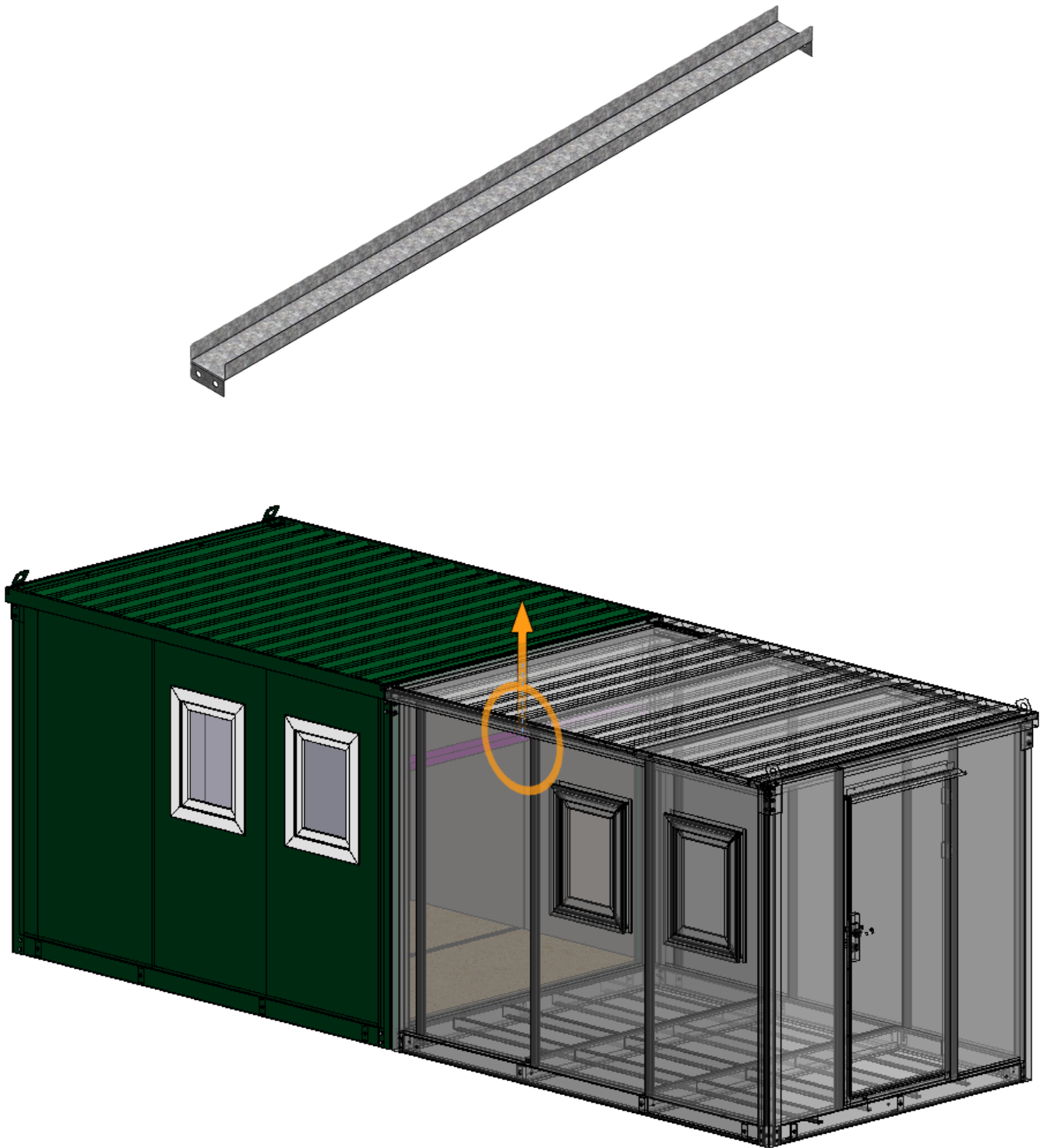

20. The part shown in the image is aligned with the holes of the previously assembled part and bolted from the inside of the container towards the sides.

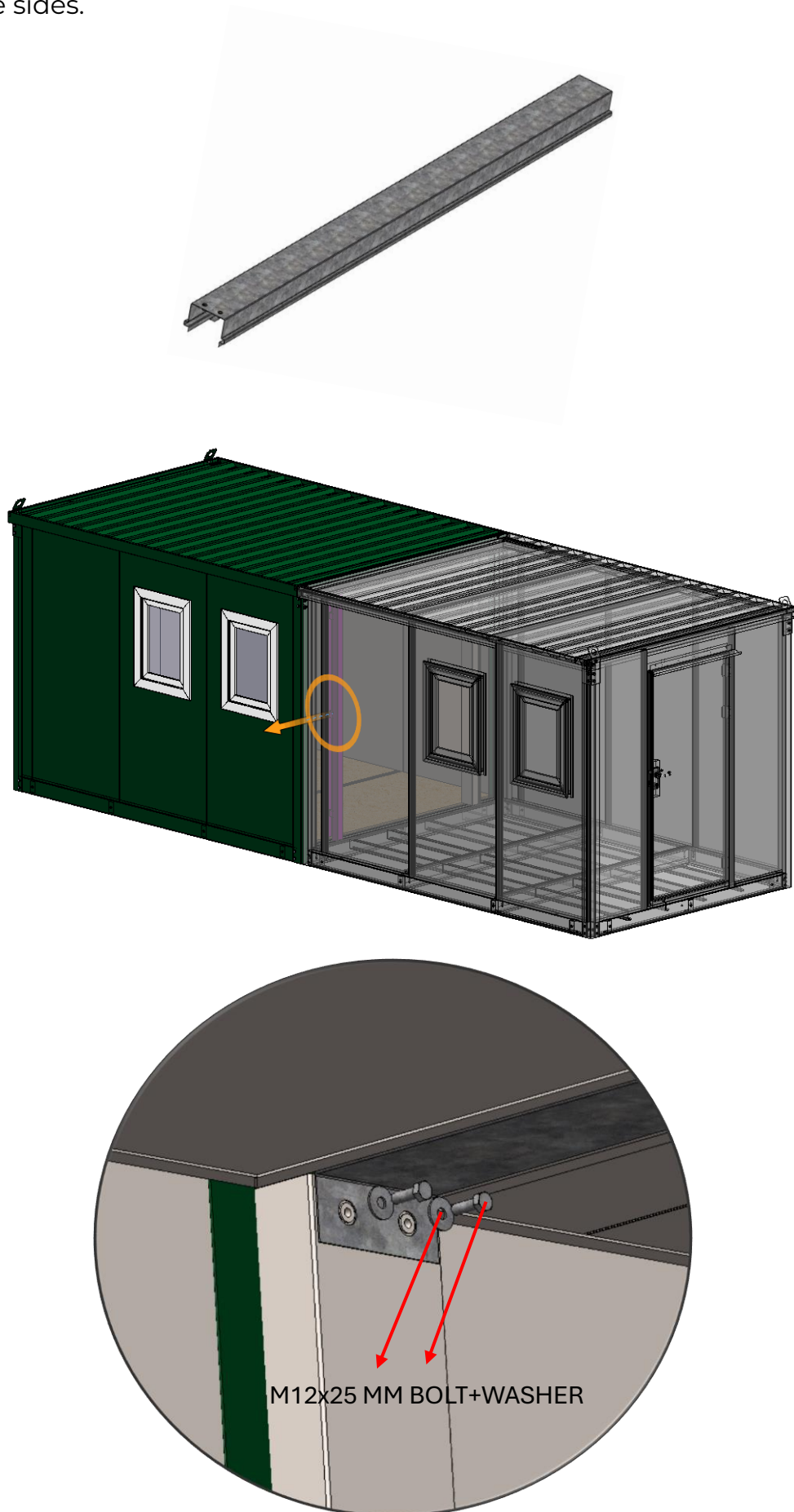

21. At this stage, the installation of the outer cladding sheet is carried out.

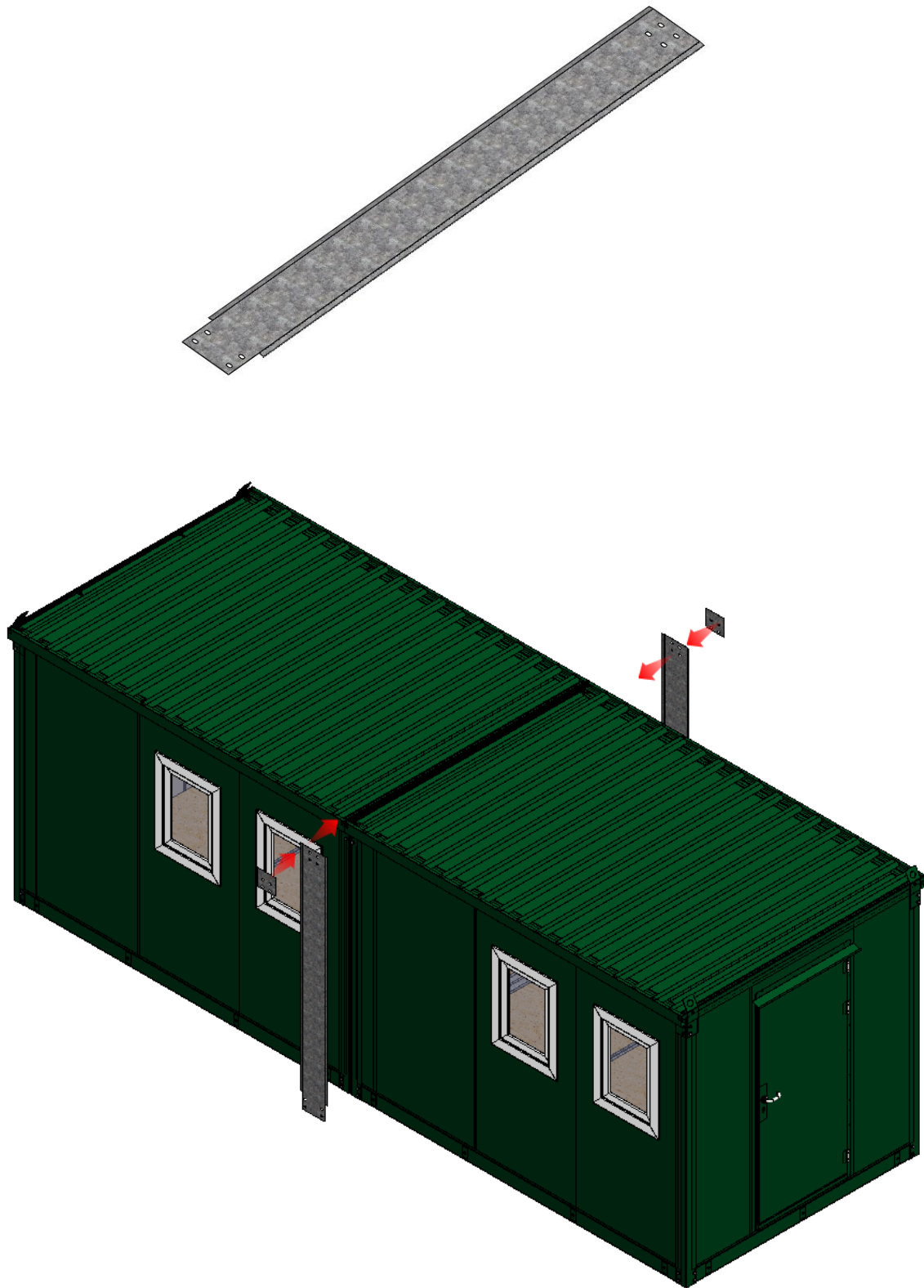

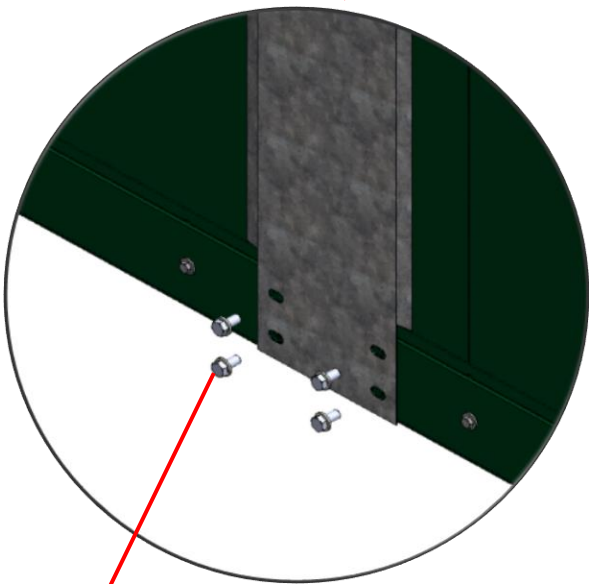
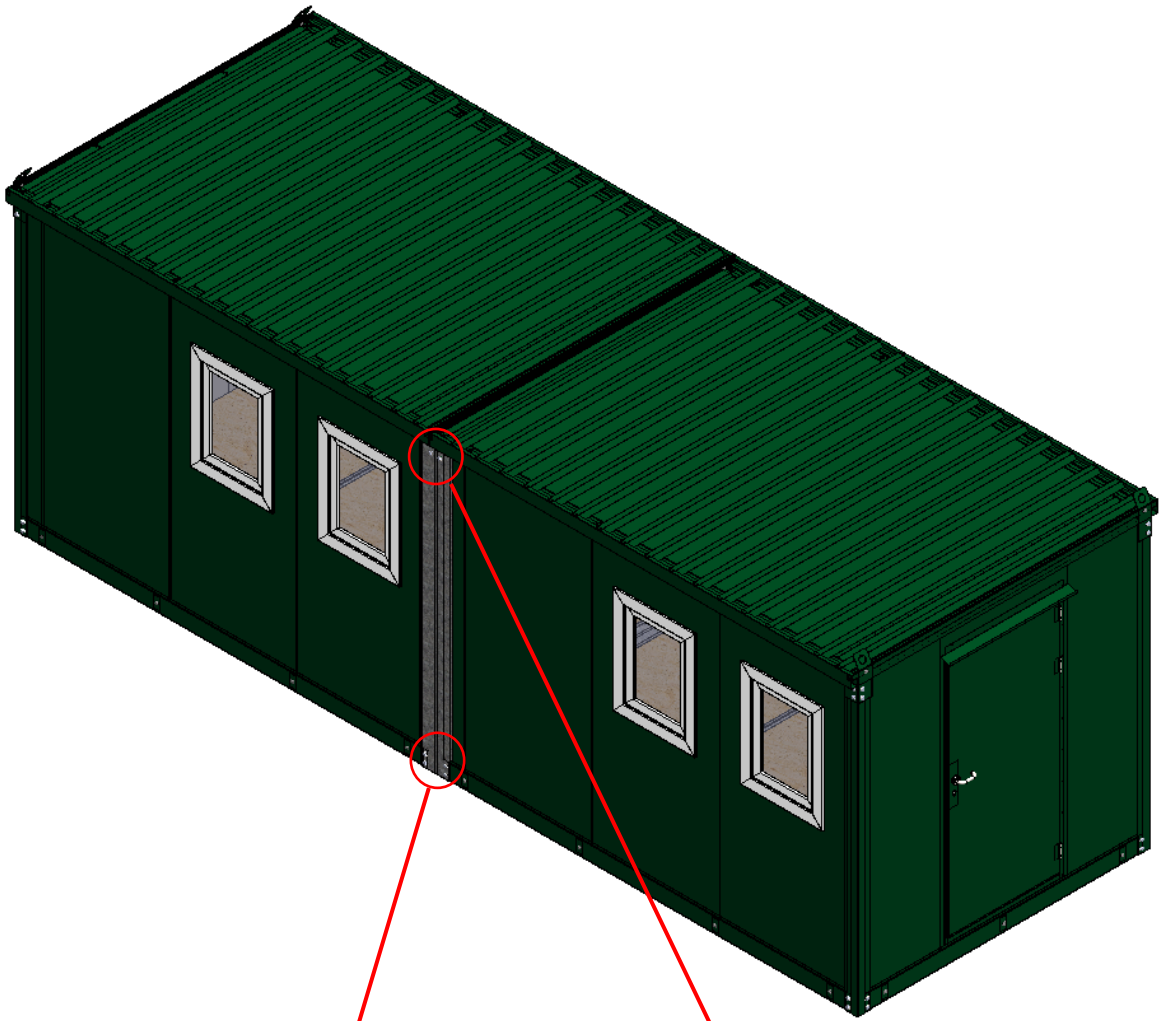

M12x25 MM BOLT+WASHER

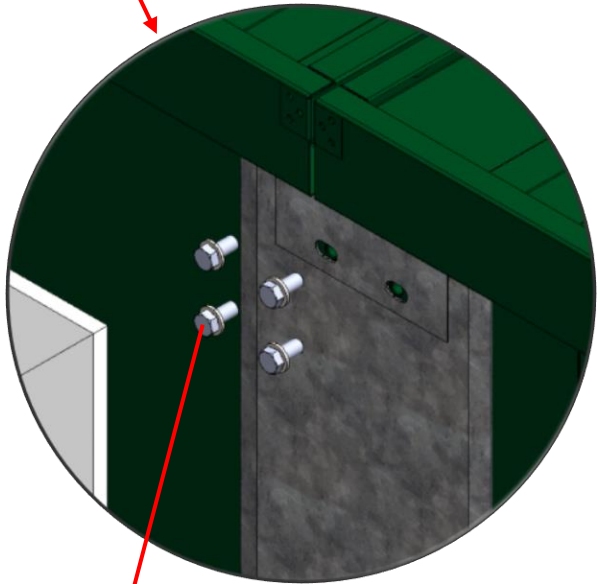

M12x25 MM BOLT+WASHER

22. The chassis connection plate is placed between the two containers.

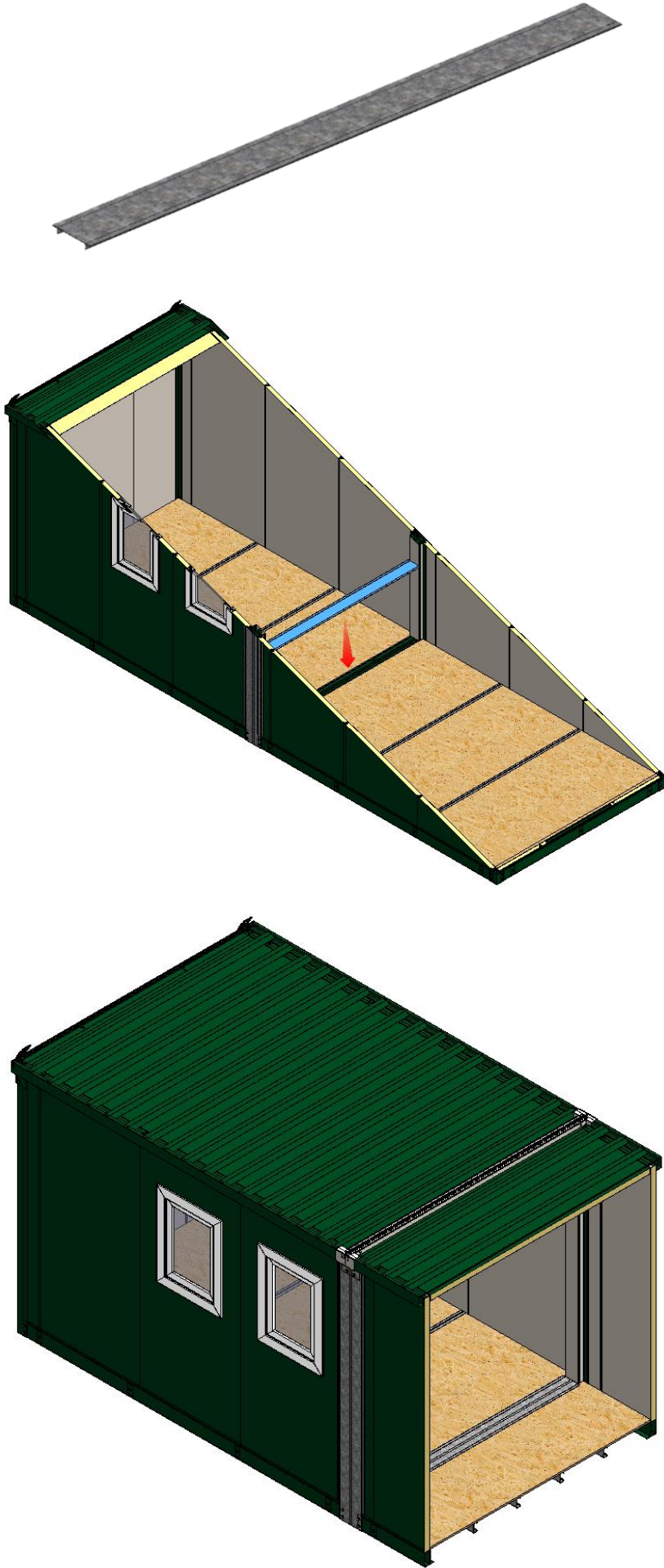

23. Finally, the roof ceiling upper cover is placed from above between the two roofs. The product is ready for use.

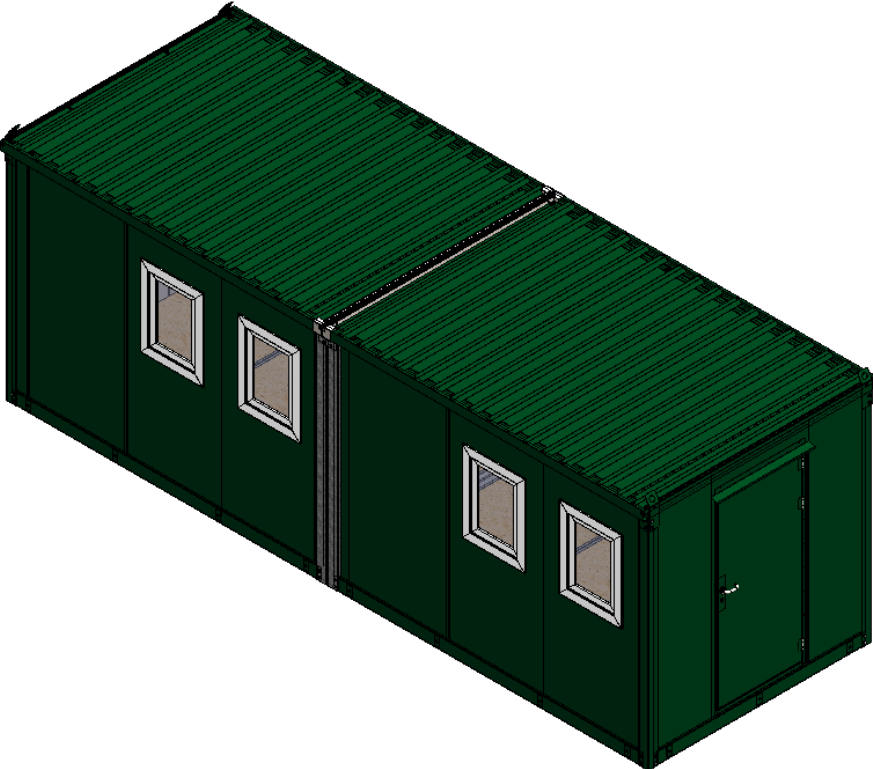
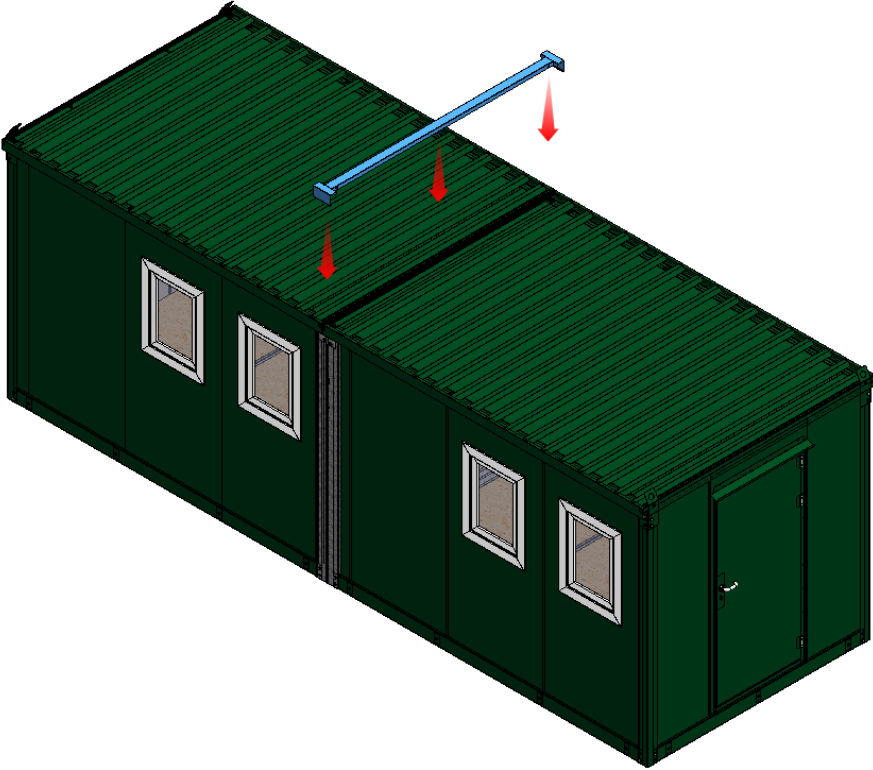

portablespace®

cabin & container hire | sales | conversions | modular

Portable Space Ltd,
Modular House, Bacton Business Park,
Stowmarket, Suffolk, IP14 4LE

T: +44(0) 01449 782123
info@portablespace.co.uk
www.portablespace.co.uk